



MORMUGAO PORT TRUST
ENGINEERING (CIVIL) DEPARTMENT

FACE SHEET TO ACCOMPANY THE TENDER DOCUMENTS

- A. 1. Name and full address of the Contractor to whom the Tender Documents are issued. :
2. Whether registered with Engineering (Civil) Department, if so, class of registration. :
3. If not registered, reference to the letter of the Chief Engineer authorising issue of the tender Documents. :
4. Date of issue of Tender Documents. :

Asst. Exe. Engineer (Accts)

- B. 1. Name of work: **Providing Signalling and Telecommunication System for Railway Network at Mormugao Port, GOA**
2. Cost of each set of Tender Documents : Rs. 10,000/-
3. Date of Sale of Tender Documents : From: 04/07/2016
To 02/08/2016 upto 15.00hrs
4. Date of receipt of tender and time : 03/08/2016 upto 15.00hrs
5. Amount of E.M.D. : Rs. 10,51,100/-
6. Date of opening of tender and time : on 03/08/2016 at 15.30 hours
7. a) Whether E.M.D. received : Yes/No.
b) if so, in which shape : Demand Draft
8. Form of contract : Percentage Rate
9. Whether tender received in duplicate : Yes/ No
10. Whether rates have been quoted in the tenders both in words and figures : Yes/ No.
11. Total No. of Tenders received for the work:

Dy. CAO (CWC)

EXECUTIVE ENGINEER (P&C)



**MORMUGAO PORT TRUST
ENGINEERING (CIVIL) DEPARTMENT**

TENDER No. CE/55/2016

**PROVIDING SIGNALLING AND TELECOMMUNICATION SYSTEM FOR
RAILWAY NETWORK AT MORMUGAO PORT, GOA.**

<u>CONTENTS</u>	<u>PAGE NOS.</u>
FIRST COVER	
Short Notice for Inviting Tender (NIT)	4
i) Undertaking by the Tenderer	5
ii) Detail Tender Notice	6-15
iii) Form of Tender	16-19
iv) Appendix to the Tender Notice	20-23
v) Proforma – 1,2 ,3 ,4, 5, & 6	24-29
vi) Instructions for Preparation and Submission Tender	30-34
vii) Joint Ventures	35-38
viii) Form of Agreement & Form of Bank Guarantee for Security Deposit	39-44
ix) General Conditions of Contract	
x) Scope of Work	45-48
xi) Additional Special Instructions	49-52
xii) Proforma of Pre Contract Integrity Pact	53-62
xiii) Conditions During Annual Maintenance Contract	63-67
xiv) Terms of Payments for Part-I - Signalling and Telecommunication System	68
xv) Check List for submission of tender	69-70
xvi) Technical Specifications	71-117
xvii) Vendor Registration Form	118-119
xviii) Drawing - a) ESP	
- b) SIP	



**MORMUGAO PORT TRUST
ENGINEERING (CIVIL) DEPARTMENT**

TENDER No. CE/55/2016

**PROVIDING SIGNALLING AND TELECOMMUNICATION SYSTEM FOR
RAILWAY NETWORK AT MORMUGAO PORT, GOA.**

F I R S T C O V E R

(TO BE SUBMITTED IN SEPARATE SEALED ENVELOPE / COVER)

Project Management Consultants

Consultants



aarvee associates
architects engineers & consultants pvt. ltd.

Ravula Residency, Srinagar Colony Main Rd., Hyderabad-82, India

Tel: +91-40-23737633; Fax: +91-40-23736277

e-mail: aarvee@aarvee.net; web: www.aarvee.net



MORMUGAO PORT TRUST
SERVING THE NATION SINCE 1885

ENGINEERING (CIVIL) DEPARTMENT
www.mptgoa.com

NOTICE INVITING TENDER

TENDER NOTICE NO.: CE/N-54/2016

TENDER No.: CE/55/2016

**PROVIDING SIGNALLING AND TELECOMMUNICATION SYSTEM FOR
RAILWAY NETWORK AT MORMUGAO PORT, GOA.**

Percentage Rate tenders in the prescribed form in sealed covers super scribing the Tender No. and due date and time are invited by the Chief Engineer for the above work as per the details given in the table below:

Cost of tender document	Estimated cost	Tender Sale From/ To	Submission on	Opening on
EMD	Completion Time	Pre Bid Meeting		
Rs.10,000/- (Rupees Ten thousand only)	Rs.10,51,09,669/-	04.07.2016 To 02.08.2016 Up to 15.00 hrs.	03.08.2016 Up to 15.00 hrs.	03.08.2016 At 15.30 hrs. Technical Bid (Cover No.I)
Rs.10,51,100/- (Rupees Ten lakhs Fifty one thousand and one hundred only)	Nine (9) Months	14.07.2016 At 15.30 hrs.		

Detailed tender notice along with complete tender documents can be downloaded from our website www.mptgoa.com on or before the last date of sale of tender document. Tenders are also available for sale at the Civil Engineering Department of Mormugao Port Trust.

For further details and general enquiries, prospective bidders may contact the Executive Engineer (Planning), telephone no. 0832 2594611, mobile 09764006075, during working hours before the last date and time of sale of tender document.

[sd/-]
Chief Engineer



**MORMUGAO PORT TRUST
ENGINEERING (CIVIL) DEPARTMENT**

TENDER No. CE/55/2016

**PROVIDING SIGNALLING AND TELECOMMUNICATION SYSTEM FOR
RAILWAY NETWORK AT MORMUGAO PORT, GOA.**

i) - UNDERTAKING BY THE TENDERER

To,
The Trustees of the PORT OF MORMUGAO,

I/We, M/s _____ have
gone through the tender document carefully and hereby confirm as under:

The complete tender set i.e. First Cover and Second Cover in sealed cover separately and together in a separate cover is returned WITHOUT any defacement, addition, alternation or interpolation. All details have been indicated separately in our tender covering letter with all the relevant Annexures and Proforma duly filled in.

I/We have submitted our tender along with Earnest Money Deposit separately enclosed in the Envelop. I/We have not indicated anywhere in the first cover the amount of our Price Bid.

I/We have not made any counter stipulation and conditions and I/We agree that in the event of any such counter conditions my/our tender will be summarily rejected and such offer will not be evaluated and considered at all by you. Percentage Rate quoted by me/us in the schedule of quantities along with other submission will remain valid for the period of 180 days from the submission of the tender.

I/We hereby declare that, all information furnished by me/us with this tender is true to best of my/our knowledge, belief and in case, if it is found that, the information furnished is not true or partially true or incorrect, I/We agree that, my/our tender shall be summarily rejected without prejudice to the right of the Board of Trustees of PORT OF THE MORMUGAO to take further action into the matter.

Witness's : _____
Signature : _____
Name : _____
Designation : _____
Address : _____
Tel. No. : _____
Date : _____

Tenderer's : _____
Signature : _____
Name : _____
Designation : _____
Address : _____
Tel. No. : _____
Date : _____



**MORMUGAO PORT TRUST
ENGINEERING (CIVIL) DEPARTMENT**

ii) DETAIL NOTICE INVITING TENDER

TENDER NOTICE NO.: CE/N-54/2016

TENDER No. CE/55/2016

**PROVIDING SIGNALLING AND TELECOMMUNICATION SYSTEM FOR
RAILWAY NETWORK AT MORMUGAO PORT, GOA.**

1. SALE OF TENDER COMMENCES: **On all working days between 04.07.2016
To 02.08.2016 from 9.30 hrs. to 12.00 hrs.
and 14.00 hrs. to 15.00 hrs.**
2. PRE BID MEETING **On 14.07.2016 at 15.30hrs.**
3. LAST DATE FOR SALE **:Up to 15.00 hrs. on 02.08.2016**
4. LAST DATE FOR SUBMISSION OF TENDER (DUE DATE) **:Up to 15:00 hrs. on 03.08.2016**
5. OPENING DATE FOR FIRST COVER (Technical Bid) **:At 15:30 hrs. on 03.08.2016.**

Note: Any clarification on the bid document bidders may contact the Executive Engineer (Planning), telephone No. 0832 2594611, mobile 09764006075, during working hours before the pre-bid meeting. Port's website [www. mptgoa.com](http://www.mptgoa.com).

MORMUGAO PORT TRUST
Civil Engineering Department,
Administrative Office Building
Headland - Sada. 403804,
Tel: 0832 252 1160

CHIEF ENGINEER
MORMUGAO PORT TRUST



**MORMUGAO PORT TRUST
ENGINEERING (CIVIL) DEPARTMENT**

TENDER No. CE/55/2016

**PROVIDING SIGNALLING AND TELECOMMUNICATION SYSTEM FOR
RAILWAY NETWORK AT MORMUGAO PORT, GOA.**

ii – DETAIL TENDER NOTICE

1. INVITATION

- 1.1 Mormugao Port Trust (MPT) invites *sealed percentage rate tenders in original under two cover bidding procedure and to the MPT's designs, drawings, relevant I.S. codes and specifications contained and referred directly/indirectly in this tender document and on Percentage basis for the work of **“PROVIDING SIGNALLING AND TELECOMMUNICATION SYSTEM FOR RAILWAY NETWORK AT MORMUGAO PORT, GOA.”**

* "Sealed" shall means sealed with wax or closed with gum, to the satisfaction of authority opening the tender.

1.2. Eligibility Criteria for tendering will be as follows:

(A) Financial Criteria :

- (a)** i) The average annual financial turnover during the last three years ending 31.03.2015 of the Tenderer should be at least **Rs. 3.16 Crores.**

Note: The above information shall be submitted along with documentary proof i.e. Income Tax Returns acknowledgement, Audited Statement of Accounts duly certified by the Statutory Auditors of the firm.

(B) Technical Criteria

The firm shall have experience of successfully completing the “similar works” during last seven years ending **March, 2016**, in either of the following:

- i) One similar work costing not less than Rs. 8.41 Crores.**
OR
ii) Two similar works each costing not less than Rs. 5.26 Crores.
OR
iii) Three similar works each costing not less than Rs. 4.20 Crores.

Note : (i) **“Similar works”** means the works involving **INSTALLATION AND COMMISSIONING OF DISTRIBUTED ELECTRONIC INTERLOCKING (DEI) FOR INDIAN RAILWAY OR ANY PRIVATE SIDINGS INTERLINKED WITH INDIAN RAILWAYS SUBSTANTIALLY COVERING THE SCOPE OF WORK IN CLAUSE 1. 3.**

1.2.1 (i) The Tenderer should have executed works in the Railways/Public Sector Government Undertakings/State Governments/Private Sector/Port Authorities.

1.2.1(ii) For the past experience of the technical criteria, credit shall be given for execution of the quantity of that specific activity executed by the firm as part of a JV, duly certified by the employer. If the employer certificate does not indicate the specific quantity of key activity /activities executed by each partner, in such a case credit for quantity of each key activity shall be given as per following provisions in order of priority.

- A) As per details given in JV agreement forming part of the relevant contract agreement.
- B) If JV agreement does not provide such details then credit shall be given in proportion of the percentage share of the firm in that JV.

1.2.2 Mandatory Technical Requirement:

The tenderer should be either Original Equipment Manufacturer (OEM) of the DEI equipment or should have Memorandum of Understanding (MOU) with OEM. **The OEM of the Distributed Electronic Interlocking (RDSO/SPN/192/2005) should be in the Part II approved list of RDSO.** MOU should be submitted along with the tender document incorporate the following:-

- a) OEM will offer technical support for commissioning of DEI.
- b) OEM will undertake certification of Factory Acceptance Test (FAT) and Site Acceptance Test (SAT).
- c) OEM will undertake verification certification and certification of pre-commissioning check list as per RDSO guidelines.
- d) OEM will offer warranty for DEI equipment's as per the condition laid in the tender document.
- e) Preference will be given in the order of priority in the clause 1.2 BI,II and III.

1.2.3 Mandatory Financial Requirement:

- a) The Tenderer shall submit Solvency Certificate from Nationalised or Scheduled bank for a minimum amount 33% of the tender value.
- b) Total Value of works in hand shall not be less than amount of Solvency Certificate submitted.

1.2.4 Mode of Selection of Contractor:

Tenderer shall have to satisfy minimum Financial and Technical eligibility Criteria mentioned in the tender at 1.2 above. Only those tenderers who satisfy minimum Financial and Technical eligibility Criteria will be further scrutinised for Mandatory Technical and Financial eligibility Criteria mentioned in the tender at 1.2.2 and 1.2.3 above. Tenderers who satisfy criteria

- mentioned in 1.2, 1.2.1, 1.2.2 and 1.2.3 above will be qualified for opening of Cover No.2 (Price Bid). During scrutiny of Price offer, lowest price offer considering all the five Parts (i.e. Part-I (Signalling & Telecommunication System), II (Annual Maintenance contract of Signalling System) will be considered. In Part – II of Bill of Quantities, tenderer shall have to quote unit Price as per details.
- 1.2.5 The contractor shall submit the techniques and methodology for the construction in Proforma 2 in case of routine work.
- 1.2.6 The tenderer shall furnish relevant information in respect of their firm etc. to ascertain their financial and technical capabilities and work experience in Proforma 1 to 6, except Proforma 2.
- 1.2.7 Offers received from the tenderer with counter stipulation and conditions will be summarily rejected and such offers will not be evaluated and considered at all.
- 1.2.8 The Port reserves the right to get any information from the tenderer before opening of the Price offer.
- 1.3 **Scope of the Work :**
- 1.3.1 The proposed work Part-I comprises of specification covered in technical requirements of Distributed Electronic Interlocking (DEI) of railway signalling works.
- 1.3.2 The DEI covered in specification shall be a microprocessor based equipment used for the operation of points, signals, level crossing gates(if any), block working with adjacent station, releasing of crank handle for manual operation of points and other controls like slots, etc. through a control cum indication panel or VDU based control panel.
- 1.3.2 It shall be possible to interface more than one CCIP or VDU control terminal or both with the DEI. For the purpose of this specification, the terminology given in latest version of IRS: S 23 and RDSO/SPN/144/2014 shall apply.
- 1.3.3 The proposed work Part – II comprises of specification covered in Annual Maintenance of Signalling System. AMC performance will reviewed every year. Maximum period of AMC is three years.
- 1.3.4 The work is required to be carried out strictly as per relevant Indian Standard Specification, RDSO specifications, Drawings and as described in Specifications and Schedule of Quantities and Rates contained in this tender document with approved quality of materials.
- 1.4 The estimated cost of the work is **Rs. 10,51,09,669/-** . The estimated cost of work is furnished herewith for the guidance of the tenderer and they are advised to make their own assessment for the same. Cost towards annual maintenance works for three years is not considered in the estimated cost put to tender.

The tenderers are required to offer their percentage at the end of each Part I in figures as well as in words at the space provided in the Schedule of Quantities and Rates, except for Part – II (i.e. Annual Maintenance contract of Signalling System), where tenderer shall have to quote as per item described.

- 1.5 The tenderer will have to work in close co-ordination with the other contractors employed, if any.
- 1.6 The quantities provided in the tender are approximate and may vary. The tenderers are strongly advised to inspect the site of work and acquaint themselves with the site conditions and quantum of works involved etc. so that they are fully aware of the nature and scope of the works to be carried out before tendering. No claim will be entertained due to variations in the quantities.
- 1.7 **The tenderers will be pre qualified based on the information furnished by them. The Second Cover of the only those qualified tenderers will be opened on the date which will be intimated to them.**

2. PROCEDURE FOR OBTAINING TENDER DOCUMENTS

- 2.1 The tender documents can be obtained in person from the Office of the Chief Engineer, Mormugao Port Trust, Administrative Office Building, Headland Sada, Mormugao, 403804. Telephone No.0832 2594628 during working hours from 9.30 hours to 12.00 hours & 14.00 hours to 15.00 hours on any working day upto the last day stipulated for the sale of tender documents, on submission of an application in writing on the firm's letterhead and on payment of the prescribed charges set out below:

a) For the complete set including drawings : **Rs.10,000/- per set**

The above charges are NON-REFUNDABLE.

- 2.2 The interested firms may alternatively download the tender documents from the Mormugao Port Trust web site www.mptgoa.com. The payment of Rs.10,000 /- (Rupees Ten Thousand only) will have to be made in that case, before the time of submission of the offers and evidence of payment made shall be enclosed or disclosed during opening of Technical cover. **Volume-I containing the General Conditions of Contract can also be downloaded from the Port's website. Volume-I shall also form the part of Cover No. I.**
- 2.3 The above prescribed charges should be paid in cash or by Demand Draft drawn in favour of "**FA&CAO**", **M P T** on any branch of a Scheduled Bank within the jurisdiction of State of Goa.
- 2.4 Tender sets will not be sent by Post OR Courier Service.
- 2.5 The tender documents are NOT TRANSFERABLE.

3. EARNEST MONEY TO BE DEPOSITED FOR THIS TENDER:

The Earnest Money to be deposited in respect of this tender is Rs.6,82,055/-

(Rupees Six lakhs eighty two thousand fifty five only) shall be in the form of Demand draft or Bankers Guarantee Bond of any Nationalised or Scheduled Bank within the jurisdiction of State of Goa payable at Vasco - Da - Gama.

4. **NUMBER OF COPIES OF TENDER TO BE SUBMITTED:**

The tenderer shall submit only one (original) copy in each of First cover and Second cover separately.

5. **RELEASE OF SITE:**

5.1 The site will be released after the work is awarded. Site along tracks will be released however work should be continued without any disturbance in existing railway operations. In case of excavation for cable trenches, cable laying and work of foundation for boxes along the tracks, work is along the tracks and contractor shall have to take enough precautions for safety of labour and equipment. It shall be the responsibility of the contractor not to cause any hindrance to the existing rail traffic and shall not obstruct the daily routine works in the vicinity. The dust, dirt and debris resulted at the site shall be controlled properly and removed daily. The complaints received in this respect will be viewed seriously and the cost of resultant damages, if any will be recovered without any reference. The Tenderer should take all these aspect into account while quoting for the tender and to complete the work within stipulated completion period.

5.2 PART II of the tender will be applicable after completion of maintenance period. The date for duration of annual maintenance contract will be defined in the maintenance certificate. Annual Maintenance Contract will be maximum of three years duration subject to performance at each of the completed years.

6. **TIME FOR COMPLETION OF THE WORK:**

6.1 The total completion period for the work is **Nine (9) months** (including monsoon) for Part – I period completed as 7days from the date of receipt of acceptance letter or from the date of release of site or part thereof, whichever is later.

6.2 Time is essence of the contract. If the tenderer stipulates a completion period longer than the one stipulated above, the same is liable for rejection.

6.3 Tenderer's specific attention is invited to the conditions of the proposed work site. The site will be released after the work is awarded. Site along tracks will be released however work should be continued without any disturbance in existing railway operations. The contractors are required to plan their construction activities accordingly without causing any hindrances to the rail traffic operations and also routine shunting movements and other activities of MPT contractor operating / working in the area.

6.4 During free maintenance period contractor shall have to maintain log book of breakdown. Any breakdown shall have to be attended to within 2 hours. In case contractor fail in providing services within stipulated period of 2 hours, then penalty will applicable as per Clause 7 below.

- 6.5 PART II of the tender will be applicable on issue of maintenance certificate wherein date for duration of annual maintenance contract will be defined. Annual maintenance contract will be **maximum of three years** duration subject to performance at each of the completed year. During maintenance period contractor shall have to maintain log book of breakdown. Any breakdown shall have to be attended to within 2 hours. In case contractor fail in providing services within stipulated period of 2 hours, then penalty will applicable as per Clause 7 below.

See Clause No.40 of the General Conditions of Contract.

7. **LIQUIDATED DAMAGES AND PENALTY:**

- 7.1 Liquidated damages for delay in completion of the works are 1/2 percent (0.5 %) of the Contract Price of work for delay of each week or part of a week subject to a maximum ceiling of 5 percent of the Contract Price. This is applicable for Part – I. However, if the work is delayed by more than 25% of the contracted completion period, the contract is liable to be terminated and the balance works are liable to be got completed by Mormugao Port Trust through some other agency at the risk and cost of the defaulting Contractor. Extension of time on MPT account in the event of any failure or delay by the port authorities to handover to the contractors position of the land necessary for execution of the work or to provide the necessary drawings or instructions or any other delay caused by the port authorities due to any other case what so ever, then such failure or delay shall in no way effect or vitiate that contract or alter the character there of or entitle the contractor to damage or compensation there of but in any such case, the port authority may grant such extension of the completion date as may be considered reasonable.
- 7.2 During free maintenance period if contractor failed in providing services within stipulated period of 2 hours, then penalty will applicable as per Clause 7.4 below.
- 7.3 Liquidated damages are not applicable for PART II of the tender. However, in case contractor fails in providing services within stipulated period of 2 hours, then penalty will applicable as per Clause 7.4 below.
- 7.4 Any breakdown shall have to be attended to within 2 hours. The delay beyond specified completion period is subject to levy of penalty of Rs.750/- per hour for first day and Rs.1,500/- per hour from next day onwards till work is completed.

8. **PROGRAMME OF WORKS:**

Every tenderer must prepare and submit with his tender applicable for Part – I detailed CPM network based programme or Bar Chart and list of control milestones for the execution of the work, keeping in mind the site conditions and the possible hindrances due to monsoon, existing rail traffic, etc duly signed and dated in accordance with Clause 15 of General Conditions of Contract & the Instructions for Preparation and Submission of Tenders. The Bar Chart and list of control milestones will form part of the tender. Wherever

necessary work shall be taken up on traffic block condition with prior permission in writing of the Traffic Manager /Chief Mechanical Engineer. In such circumstances all the items required for the traffic block condition shall be procured and stacked at site. Non-compliance of the above may lead to rejection of the tender.

9. **MAINTENANCE PERIOD:**

The free maintenance period is 1 (one) year for works covered under Part-I, of this contract from date of completion of the entire work as certified by the Chief Mechanical Engineer.

10. **FACILITIES TO THE CONTRACTOR:**

Tenderers are advised to price their bids after taking into account, among other provisions of the tender documents:

- a) Secured Advance against materials brought to site for Permanent Works, will be paid to the contractor. (Refer Clause No. 54 (1) (b) of (G.C.C)
- b) MPT will generally not supply any material for the work.
- c) MPT will supply water for construction purpose subject to availability as per the Special Condition of Vol .I Clause No. 9.19. In the event water is not supplied by MPT, the contractor will have to make his own arrangements for water which shall be from an approved source (Refer Appendix – II).
- d) It is possible to give electric supply by MPT subject to availability during execution of Signalling work as per Special Conditions of contract Vol. I Clause No. 9.20. The contractor will have to make his own arrangements for drawing the electricity which shall be approved by MPT. Contractor has to maintain generator set of the adequate capacity for the electrical supply in case of emergency at his own cost (Refer Appendix – II).

11. **FACILITIES NEED TO BE PROVIDED BY THE CONTRACTOR:**

Tenderer's are advised to price their bids after taking into account the facilities need to be provided by them free of cost to the Employer, which shall include following facilities.

- a) No payment for testing of any materials from reputed laboratory will be made to the contractor.
- b) Contractor shall at his cost obtain all necessary permissions/clearances of statutory/non-statutory authorities as applicable, test certificates along with inspection report of the railway materials brought to site, for successful completion of the work.
- c) Stamp Duty on the Contract Agreement will be borne by the contractor.
- d) Contractor shall obtain inspection certificates from RDSO / RITES as applicable at his own cost as per the BOQ.

12. **EXPENSES INCURRED BY THE TENDERER:**

Mormugao Port Trust will not reimburse any costs or expenses incurred by the tenderer in connection with the preparation or delivery of this tender, including costs and expenses related to visit the site.

13. **INSPECTION OF SITE:**

Tenderers are strongly advised to inspect the site of work and acquaint themselves with the site conditions and quantum of work involved etc. before tendering. Access to the site for inspection will be arranged by Executive Engineer, Engineering Civil Department, Mormugao Port Trust, Administrative Office Building, Headland Sada, Mormugao Vasco, Goa - 403804, Telephone No. 0832 2594611. Mobile: 09764006075.

14. **RIGHT OF ACCEPTANCE / REJECTION OF ANY TENDER :**

The Board of Trustees of the Port of Mormugao reserves the right to reject any or all tenders or to accept any tender in part or whole and does not bind itself to accept the lowest or any tender.

15. **DEADLINE FOR RECEIPT AND OPENING OF TENDER:**

- 15.1. The tenders duly completed in accordance with the "Instructions for preparation and submission of tenders" contained in this tender document should be placed in the tender box (marked "Tender No. **CE/55/2016**") kept outside the cabin of the Asst. Engineer (Accts), Civil Engineering Department, Mormugao Port Trust, upto due date as indicated in face sheet.

The First Cover - Technical Cover will be opened at 15.30 hrs. on the due date in the presence of such of the tenderers who may wish to remain present.

- 15.2 The tenders whether sent by Courier/ Post or by hand delivery must reach this office on or before the due date and time. OFFERS RECEIVED LATE WILL NOT BE CONSIDERED EVEN THOUGH POSTED BEFORE THE DUE DATE AND TIME.
- 15.3 Offers sent by telex/telegram/fax will not be considered.
- 15.4 Unsigned tenders will not be considered.

16. **PROCEDURE FOR SUBMISSION OF TENDERS:**

The tenders are required to be submitted in accordance with procedure set out at Clause No.4 of Instructions for Preparation and Submission of tenders.

17. Further to provision to this contract the other recoveries shall also include deduction of Income Tax at source, works contract tax, cess, etc. as may be applicable as per the prevailing rules and regulations.

18. Tax at source will be applicable on the value of works contract in terms of Section 28 of Goa Value Added tax (Act) 2005. The present rate of such tax is 5% on the value of the work contract will be deducted from the bill(s) payable to the contractor. The contractor should indicate the registration

- number with all the applicable statutory authorities regarding Service Tax, VAT, Sale tax (LST & CST).
19. The tenderers are requested to obtain Certificate of Registration under Rule No.24 of the Building and other Construction Workers Central Rules, 1998 from the office of the Asst. Labour Commissioner, Mormugao.
 20. The contractor should comply the provisions of the Building and Construction Workers (Regulations of Employment and Conditions of Services) Act, 1996. The Act envisages that every Contractor shall obtain registration certificate from the Registering Officer, if he engages 10 or more workers for the work.
 21. Tenderers are requested to submit Audited Balance sheets along with their tender and quote their Permanent Account Number (PAN).
 22. **VALIDITY OF THE TENDER:**

The tenders shall remain valid for a period of 180 days from the date of submission of Bid offer.

CHIEF ENGINEER
MORMUGAO PORT TRUST
MORMUGAO – GOA

Mormugao, Headland Sada.
Dated: 04.07.2016



**MORMUGAO PORT TRUST
ENGINEERING (CIVIL) DEPARTMENT**

TENDER No. CE/55/2016

**PROVIDING SIGNALLING AND TELECOMMUNICATION SYSTEM FOR
RAILWAY NETWORK AT MORMUGAO PORT, GOA.**

iii - FORM OF TENDER

**The Chief Engineer,
Mormugao Port Trust,
MORMUGAO HEADLAND SADA (GOA).**

I/We _____ do hereby offer to execute the work comprised in the annexed Tender Notice **PROVIDING SIGNALLING AND TELECOMMUNICATION SYSTEM FOR RAILWAY NETWORK AT MORMUGAO PORT, GOA.** in strict accordance with the Instructions to Tenderers, General Conditions of Contract (GCC), Specifications, etc. at the rate entered in the attached Schedule of Quantities and Rates.

- I/We undertake to complete the work included in the Schedule of Quantities and Rates in Part – I within **Nine (9) months** from the date receipt of work order or date of release of site whichever is later. Completion of Part – II is three years maximum subject to review of performance every year after completion of free maintenance period of one year and issue of maintenance certificate. I/We also agree that this tender will remain open for acceptance until disposed off by the Trustees of Port Mormugao. I/We have independently considered the question of the amount of loss or damage likely to result to the Trustees from the delay on my/our part in the performance of the contract and I/We agree that the Liquidated damages at the rate of 0.5% of the contract price per week or part thereof delay in work subject to a maximum ceiling at 5% of the contract price represents a fair estimate of the loss likely to result from the delay. Liquidated damages are applicable for Part – I. I/We agree that in case of free maintenance period and Part – II failure in providing services penalty will applicable as mentioned below and same shall be deducted from the bill payments:

Any breakdown shall have to be attended to within 2 hours. The delay beyond specified completion period is subject to levy of penalty of Rs.750/- per hour for first day and Rs.1,500/- per hour from next day onwards till work is completed.

3. I/We enclose herewith a sum of **Rs.10,51,100/- (Rupees Ten lakhs fifty one thousand one hundred only)** towards **earnest money deposit** in the form of Demand draft as proof of my/our willingness to enter into the contract if my/our tender is accepted.
4. In the event of my/our tender being accepted, I/We agree to enter into a contract in the prescribed form with such alterations or additions thereto which may be necessary to give effect to the acceptance of this tender and such contract shall contain and give full effect to the specifications, Schedule of Quantities and Rates attached to this tender.
5. I/We also agree, if awarded the contract that the earnest money lodged with this tender will be retained by the Trustees towards part of the Security Deposit and to make further deposit by cheque/demand draft of a Bank Guarantee, within fourteen days or such extension of the period permitted by the Chief Engineer, in writing, after receipt of information that my/our tender has been accepted by the Port Trust.
6. I/We further agree, if awarded the contract, to lodge the Retention Money equivalent to 5% of the contract price of my/our tender by way of deductions from my/our bills at the rate of 10% of the gross value of work certified in each bill till the amount of 5% of the contract price is accumulated.
7. Should this tender be accepted, I/we hereby agree to abide by and fulfil all the terms and conditions of the said tender annexed hereto, so far as applicable or in default thereof to forfeit and pay the Board of Trustees and/or its assignees, the sum of money mentioned in the said conditions and to execute and agreement in the prescribed form with the Mormugao Port Trust within 30 days of the award of the contract, or in default thereof, to forfeit the Earnest Money deposited by me/us. Unless and until, a formal agreement is prepared and executed, this tender together with your written acceptance thereof shall constitute a binding contract between us.
8. I/we undertake, if our tender is accepted, to commence the work within 7 days of receipt of the Chief Engineer's orders to commence and to complete and deliver the whole of the work comprised in the contract within the time allowed for the work.
9. A sum of **Rs.10,51,100/- (Rupees Ten lakhs fifty one thousand one hundred only)** has been deposited by me/us with the Financial Adviser and Chief Accounts Officer of Mormugao Port Trust as Earnest Money, the full value of which is to be absolutely forfeited to the Board of Trustees without prejudice to any other rights or remedies of the said Board, should I/we fail to commence the work specified in the above mentioned memorandum, otherwise the said sum of **Rs.10,51,100/- (Rupees Ten lakhs fifty one thousand one hundred only)** shall be detained by the Port Trust as a part of the Security Deposit as aforesaid.
10. I/we agree to abide by this tender to be valid for the period of six months from the date fixed for receiving/opening the same and it shall remain binding upon me/us and may be accepted any time before the expiration of that period.
11. I/we further agree that if I/we withdraw the tender before the expiration of this period of six months, or fail to execute an agreement in the form aforesaid

within 30 days from the date of award of contract, the Earnest Money deposited shall be forfeited to the Board.

12. I/we understand that the Board is not bound to accept the lowest or any tender you may receive and may reject the same (the lowest) or any other tender without assigning any reason therefore.
13. "I have read and understood the General conditions and specification of the work which are printed in Volume – I supplied to me by the Department which will form a part of tender and this shall remain binding on me".
14. I/We have enclosed herewith the following completed documents as required under instructions to tenderers:-
 - a) Organisation Chart.
 - b) List of similar works carried out by me/us.
 - c) Bar Chart/ CPM Chart.
 - d) List and description of main plant and equipments proposed to be used on this work and Proforma 1 to 6.
 - e) Check list and Vendor Registration Form
15. I/We have inspected the site and I am /we are fully aware of the work to be carried out while tendering for the contract.
16. (A) Mine is a proprietary firm and I am sole proprietor of the firm. My firm is/is not registered with Registrar of firms.

Name: _____ Age _____ Years

(B) Ours is a partnership firm and the names of all major partners are given below:

NAME	AGE
1. _____	_____ Years
2. _____	_____ Years
3. _____	_____ Years
4. _____	_____ Years

We understand and confirm that if our offer is accepted, the contract will be entered into with the above mentioned partners only and the Trustees will not recognize or deal with any minor partners of their guardians.

(C) Ours in a company with liability and a copy of our Memorandum and Articles of Association will be sent for perusal upon acceptance of our offer.

Proposed contract is intended to be signed by a duly constituted Attorney and original power of Attorney in his favour will be submitted for perusal immediately on acceptance of the tender.

17. The name and address of our Banker is ** _____

18. My/our permanent Income Tax Accountant No. is _____.

Witness's

Tenderer's

Signature _____ Signature _____

Name _____ Name _____

Address _____ Address _____

Tel. No. _____ Tel No. _____

Hand Phone (Mobile) No. _____

Date _____ Date _____

N. B. : Strike out whichever is not applicable.

Here the Name of the Bank should be stated.

NAME AND ADDRESS OF TENDERER:-

SIGNATURE OF TENDERER

Witness: - _____

Date: _____ Day of _____ 2016

Witness: - _____

Witness: - _____



An ISO 9001 : 2008 Port
ISPS CODE Compliant

**MORMUGAO PORT TRUST
ENGINEERING (CIVIL) DEPARTMENT**

TENDER No. CE/55/2016

iv) APPENDIX TO THE TENDER NOTICE

**PROVIDING SIGNALLING AND TELECOMMUNICATION SYSTEM FOR
RAILWAY NETWORK AT MORMUGAO PORT, GOA.**

APPENDIX- I

The following Clauses shall be read in conjunction with respective Clauses of
General Conditions of Contract (GCC)

Sr. No.	Particulars	Clause of G.C.C.(Vol. I)	
1.	Amount of Initial Security and Time. Contract Price means sum of quoted offer of Part – I.	11(1)	Five percent of the contract price and 27 months.
2.	Period for commencement from the Chief Engineer's orders to commence.	38	7 days
3.	Period of Completion Applicable for Part I	40	Nine (9) months
4.	Amount of liquidated damages. Applicable if Completion of Part I delayed beyond scheduled date of completion	43	Calculated at 0.5% value of the contract per week of seven days, or part thereof subject to a ceiling of 5% value of the contract.
5.	Free Maintenance Period. Applicable for Part I	45(1)	12 (Twelve) months
6.	Percentage of retention from each running account bill	54(1)	10%.
7.	Limit of Retention Money	54(1)	5% value of the contract.
8.	Total initial Security Deposit and Retention Money.	11(1) 54(1)	10% value of the contract.
9.	Minimum amount of interim Certificate applicable till completion of works for Part I.	54(1)	Rs.50,00,000/-.
10.	Time within which payment to be made after contractor's submission of the bill based on joint measurement.	54(1)	100 % within 15 working days

11.	Mobilisation Advance	N.A	Not Applicable
12.	Interest rate on mobilization advance.	N.A	Not Applicable
13.	Mode of recovery of Mobilisation Advance	N.A	Not Applicable
14.	Variation in price of labour and materials.	70	Not Applicable to this contract.
15.	Arbitration Clause	66	Not Applicable to this contract.
16.	Minimum amount of third party Insurance.	Cl. No.13 to 15 of Special Instructions	5% of the tendered amount.
17.	Lease rent.	Cl. No.9 to 11 of Special Instructions	Refer Appendix III

Dated this day of2016

Signature in the capacity of

..... duly authorised to sign tender for and

on behalf of

(IN BLOCK LETTERS)

ADDRESS :

Witness :

.....

Occupation:

.....



APPENDIX- II

**MORMUGAO PORT TRUST
ENGINEERING (CIVIL) DEPARTMENT**

TENDER No. CE/55/2016

**Name of Work: PROVIDING SIGNALLING AND TELECOMMUNICATION
SYSTEM FOR RAILWAY NETWORK AT MORMUGAO PORT, GOA.**

MATERIALS TO BE SUPPLIED BY THE DEPARTMENT FOR THE WORK

Sr. No.	Description of materials	Approx. qty. to be supplied	Unit	Rate in Figures/Words	Place of Delivery
1.	Water	--	Cubic Metre	Rs.40/m3 (Rupees Forty only)	Ref. Clause No.9.19 of Special Conditions – Vol.I
2.	Electric Power	----	KWH	Electric supply as per the relevant rate applicable and supply point will be indicated by the CME's Department.	Ref.Clause No.9.20 of Special Conditions – Vol.I
3.	Harbour Entry Permit (HEP)	--	Per Person per day/month	As applicable	To be Collected from Traffic Department

SIGNATURE OF THE CONTRACTOR



APPENDIX- III

MORMUGAO PORT TRUST
ENGINEERING (CIVIL) DEPARTMENT

TENDER No. CE/55/2016

ESTATE RENTAL CHARGES

**Name of Work: PROVIDING SIGNALLING AND TELECOMMUNICATION SYSTEM
FOR RAILWAY NETWORK AT MORMUGAO PORT, GOA.**

Sr. No.	Description	<u>Rate*</u> Rs.	Remarks
1.	Licence fees on Port land for maintenance office buildings and other structures.	Rate will be charged as per scale of rates prevailing during period of contract.	Payment shall be made to CDC Section, Finance Dept based on the recovery advice.

NOTE : Location of suitable area subject to the availability shall be decided by the Chief Engineer.

* Rate per 10 sq. m. or part thereof per calendar month or part thereof.

SIGNATURE OF THE TENDERER



An ISO 9001 : 2008 Port
ISPS CODE Compliant

PROFORMA 1

**MORMUGAO PORT TRUST
ENGINEERING (CIVIL) DEPARTMENT**

TENDER No. CE/55/2016

**Name of Work: PROVIDING SIGNALLING AND TELECOMMUNICATION
SYSTEM FOR RAILWAY NETWORK AT MORMUGAO PORT, GOA.**

**TOTAL PAYMENT RECEIVED FROM EXECUTION OF SIMILAR WORK CARRIED
OUT AS PRINCIPAL CONTRACTOR DURING EACH OF LAST SEVEN YEARS
ENDING 31ST MARCH 2015.**

(Rs. in lakhs)

Sr. No.	Tender No.	Name of the work	Employer	Amount Received Rs.
1	2	3	4	5

NAME, SIGNATURE
& SEAL OF TENDERER :

DATE :



PROFORMA 2

MORMUGAO PORT TRUST
ENGINEERING (CIVIL) DEPARTMENT

TENDER No. CE/55/2016

**Name of Work: PROVIDING SIGNALLING AND TELECOMMUNICATION
SYSTEM FOR RAILWAY NETWORK AT MORMUGAO PORT, GOA.**

METHOD STATEMENT

(The tenderer shall submit Method Statement i.e. a write up with full technical particulars and explanatory drawings indicating the method of construction having regard to all reasonable contingencies that may arise in the nature of work put to tender as required under Clause No.1.2.2 of eligibility criteria stipulated in Tender Notice. This shall also cover procedures adopted during change over from manual system to signalling mode without affecting on going operations).

NOTE: The purpose of the Method Statement is limited to assess the tenderer's technical capabilities and the acceptance of a tender does not imply the Mormugao Port Trust's concurrence to the Method Statement.

NAME, SIGNATURE
& SEAL OF TENDERER :

DATE :



PROFORMA 3

MORMUGAO PORT TRUST
ENGINEERING (CIVIL) DEPARTMENT

TENDER No. CE/55/2016

**Name of Work: PROVIDING SIGNALLING AND TELECOMMUNICATION
SYSTEM FOR RAILWAY NETWORK AT MORMUGAO PORT, GOA.**

**LIST OF MAJOR TOOLS, PLANT AND MACHINERY, SURVEY EQUIPMENTS,
TESTING APPARATUS IN WORKING CONDITION AND
OWNED BY THE TENDERER
(USE CONTINUATION SHEET IF REQUIRED)**

SR. NO.	DESCRIPTION	NO. OF UNITS	YEAR OF PURCHASE	PRESENT CONDITION	PRESENT LOCATION
	MAKE				
	CAPACITY				
1	2	3	4	5	6

NAME, SIGNATURE
& SEAL OF TENDERER :

DATE :



PROFORMA 4

MORMUGAO PORT TRUST
ENGINEERING (CIVIL) DEPARTMENT

TENDER No. CE/55/2016

**Name of Work: PROVIDING SIGNALLING AND TELECOMMUNICATION
SYSTEM FOR RAILWAY NETWORK AT MORMUGAO PORT, GOA.**

LIST OF PROFESSIONALS TO BE DEPUTED FOR THE SUBJECT WORK
(USE CONTINUATION SHEET IF REQUIRED)

SR. NO.	NAME OF PERSON	AGE	PROFESSIONAL EXPERIENCE DETAILS	POSITION HELD IN THE FIRM	SINCE WHEN
		QUALIFICATION			
1	2	3	4	5	6

NAME, SIGNATURE
& SEAL OF TENDERER :

DATE :



An ISO 9001 : 2008 Port
ISPS CODE Compliant

PROFORMA 5

MORMUGAO PORT TRUST
ENGINEERING (CIVIL) DEPARTMENT

TENDER No. CE/55/2016

**Name of Work: PROVIDING SIGNALLING AND TELECOMMUNICATION
SYSTEM FOR RAILWAY NETWORK AT MORMUGAO PORT, GOA.**

QUALIFICATION AND EXPERIENCE OF LEADING EMPLOYEES OF THE FIRM
(USE CONTINUATION SHEET IF REQUIRED)

SR. NO.	NAME OF PERSON	AGE	PROFESSIONAL EXPERIENCE DETAILS	POSITION HELD IN THE FIRM	SINCE WHEN
		QUALIFICATION			
1	2	3	4	5	6

NAME, SIGNATURE
& SEAL OF TENDERER :

DATE :



PROFORMA 6

MORMUGAO PORT TRUST
ENGINEERING (CIVIL) DEPARTMENT

TENDER No. CE/55/2016

**Name of Work: PROVIDING SIGNALLING AND TELECOMMUNICATION
SYSTEM FOR RAILWAY NETWORK AT MORMUGAO PORT, GOA.**

EXPERIENCE TO WORK IN TRAFFIC BLOCK CONDITIONS
(USE CONTINUATION SHEET IF REQUERUIRED)

Sr. No.	Name of the Work	Client	Details, Period, etc.	Documentary Evidence if any

NAME, SIGNATURE
& SEAL OF TENDERER

DATE:



MORMUGAO PORT TRUST
ENGINEERING (CIVIL) DEPARTMENT

TENDER No. CE/55/2016

**Name of Work: PROVIDING SIGNALLING AND TELECOMMUNICATION
SYSTEM FOR RAILWAY NETWORK AT MORMUGAO PORT, GOA.**

(vi) - INSTRUCTIONS FOR PREPARATION AND SUBMISSION OF TENDER

1. EARNEST MONEY DEPOSIT (EMD) :

- 1.1 The Earnest Money shall be lodged by the tenderer on the understanding that in the event of the tenderer withdrawing his tender before the expiry of the tender validity period stipulated in the Tender Notice, the Earnest Money deposited by the tenderer shall be forfeited.
- 1.2 Earnest Money Deposit will be accepted only in the form of Demand Draft or Bankers Guarantee Bond issued from any Nationalised or Scheduled Banks having office in the State of Goa. The same shall be drawn in favour of "FA&CAO/MPT" and payable at Vasco -de- Gama. **EMD in cash or in any other form will not be accepted.**
- 1.3 For Two cover bidding procedure i.e. one is Technical Bid and other is Financial Bid, the E.M.D. should be placed in a third cover. All the three covers shall be placed in fourth cover properly sealed. The inner envelopes should be separately marked "EMD", "Technical bid" and "Financial Bid". The outer envelope should bear identifications such as (i) Tender No., (ii) Description of work, (iii) Bidders Name and Address and (iv) Time and Date of Bid opening.
- 1.4 Bids if not accompanied by the requisite Earnest Money Deposit (EMD) and in the manner described at 1.2 and 1.3 above is liable to be rejected at the discretion of the Port.
- 1.5 Proper receipt for having received the Earnest Money Deposit (EMD) shall be issued to the bidders after opening the bids.

1.6 Refund of Earnest Money Deposit:

Mormugao Port Trust will return, generally within 10 days of the opening of the Price Covers of the tenders; the Earnest Money Deposits lodged by all tenderers except for those whose offers are ranked as the first three lowest acceptable tenders. Such tenderers are requested to contact the Asst. Engineer (Accts), Engineering (Civil) Department in the Head Office for claiming the same.

- 1.7 E.M.D. of other tenderers, i.e. two among the first three lowest tenderers will be refunded to them only after acceptance of work order by successful tenderer. E.M.D. of successful Contractor will be retained as part of Initial Security Deposit (I.S.D.)
- 1.8 The return of Earnest Money will be effected either by way of returning the Banker's cheque lodged by the tenderers or by issuing a cheque drawn on the State Bank of India. The Mormugao Port Trust will not be responsible for reimbursing to the tenderers the Banker's commission for en-cashing the cheque.

2. **INSPECTION OF SITE**

Tenderers are advised to inspect the site before tendering and fully acquaint themselves about the nature and scope of the works to be carried out and other factors relating to the performance of the contract as no claims or complaint/s will be entertained after award of the contract in this context.

3. **DECLARATION AS REGARDS EMPLOYMENT OF MPT'S FORMER CLASS- I OFFICERS**

The tenderer should furnish information before the award of the contract, whether he himself or any of his partners, Directors, or employees had held a Class I post in the Mormugao Port Trust within the period of last two years.

4. **PROCEDURE FOR PREPARATION OF TENDERS BY TENDERERS:**

- 4.1 The tenderer shall complete the annexed Tender, Schedule of Quantities and Rates and insert all the information called for therein, sign and date them. Unsigned tenders will not be considered. The tenderer shall furnish with the tender a Notarized copy of the Power of Attorney, or other acceptable authorisation of the person/s signing the tender, unless such copy is already registered with the Mormugao Port Trust.
- 4.2 Tenderers must return the complete tender set. The tender documents shall not be defaced or detached. Additions and alterations or interpolations shall not be made in the tender document.
- 4.3 Unless otherwise stipulated in the Tender Notice, the tenderer shall submit his tender strictly based on the official design and specifications.
- 4.4 All the tenderers shall submit/ furnish along with the tender the followings:-
 - (a) List of similar works executed by the tenderer.
 - (b) Detailed CPM network based programme for execution of the work for Part I. The network chart shall show the various identifiable activities, their logical inter-dependencies, the duration of each activity, backed up by break-up of the resources based on which the duration has been estimated, the source (owned/ to be purchased/ hired) of the envisaged resources. The network shall show earliest and latest week number of

commencement and completion of each activity. Based on an analysis of such a network programme/bar chart and a list of control milestones shall also be submitted. The network and list of milestones shall be signed and dated by the tenderer and shall be treated as an integral part of his tender. The tenderer should note that the completion period includes monsoon and it is possible that works may be affected by monsoon. However he has to plan all his activities in such a manner that work will be completed in the stipulated period.

- (b) All tenderers must furnish complete information in accordance with this document along with Proforma 1 to 6.
- (c) Check list and Vendor Registration Form duly filled in
- (d) Joint Venture (JV) application form (if applicable).

5. **SUBMISSION OF TENDER:**

The tenderer is required to submit his tender in the manner described below.

5.1 **Tenders invited under Two cover system:**

5.1.1 The tender is required to be submitted in Two cover system and First cover shall contain:

- (a) All the tender document including the required information of the tenderer's along with the Proforma duly filled in excluding Preamble to Schedule of Quantities and Rates, Schedule of Quantities and Rates and Form of Tender which is required to be sealed separately in second cover.
- (b) All the accompaniments set out in Clause 4.4 above
- (c) The First sealed cover shall be super scribed with the Tender Number, Name of Work, Due Date and with the words "TECHNICAL BID (Cover No.1) – To Chief Engineer" and should bear in the bottom left corner, the Name of Tenderer.
- (d) Duly executed power of attorney in the name of Bidders authorised representatives to act on behalf of Bidder in case of Firms/ Partnership duly authenticated by a Notary Public.
- (e) **All Technical Certificates and Financial Statements shall be certified by the Statutory Auditors of the firm or notarized by Notary.**

5.1.2 The Second sealed cover shall contain Preamble to Schedule of Quantities and Rates, Schedule of Quantities and Rates for Part I and II and Form of Tender in the form as described in Clause No. 5.1.1(a) above as the case may be. The Second sealed cover shall be super scribed with the Tender Number, Name of the work, Due date and with the words "FINANCIAL BID – (Cover No.2)" and should bear in the bottom left corner, the Name of the Tenderer.

- 5.1.3 **The Tenderer must ensure that his tendered amount or rates are not mentioned, either directly or indirectly in any of the papers enclosed in the First cover. If any such mention is made there, the tender is liable to be treated as invalid and will not be considered.**
- 5.1.4 The EMD shall be placed in "Third cover" marked as "EMD" and all the three covers shall be placed in "Fourth cover" properly sealed which shall be superscribed with the Tender Number, Name of the work, Due date and with the words "Complete Tender" and shall be addressed to the Chief Engineer, Mormugao Port Trust. The Name of Tenderer shall appear in the bottom left corner of the cover. Tenderer should also write on this cover whether the tender is submitted against EMD lodged with the tender or against Permanent Earnest Money Deposit.

5.2 **Delivery of Tenders**

- 5.2.1 (a)The tenders duly completed in accordance with the "Instructions for preparation and submission of tender" contained in this tender document should be placed in the Tender Box (marked "**Tender No. CE/55/2016**") kept outside the cabin of the Asst. Engineer (Accts), Civil Engineering Department, Administrative Office Building, Mormugao Port Trust, Headland Sada, Mormugao, 403804, Tel: 0832 2594628. upto 3.00 pm on due date as indicated in face sheet and First cover Chief Engineer, Mormugao Port Trust offers will be opened at 3.30 p.m. on the same date in the presence of such of the tenderers who may wish to be present.
- 5.2.2. The tenders addressed to the Chief Engineer/MPT whether sent by post or by hand delivery must reach the office of the Asst. Engineer (Accts), Civil Engineering Department, Mormugao Port Trust, Administrative Office Building ,Headland Sada , Mormugao ,403804, on or before the due date and time. **OFFERS RECEIVED LATE WILL NOT BE CONSIDERED EVEN THOUGH POSTED BEFORE THE DUE DATE AND TIME.**
- 5.2.3. Offers sent by Telex/Telegram/FAX will **not** be considered.
- 5.2.4. Unsigned tenders will not be considered.

6. **OPENING OF TENDERS:**

- 6.1 The tender will be opened at the time and date notified in the Tender Notice, in the presence of such of the tenderers who may wish to be present.
- 6.2 In the case of Two cover tenders, only the First cover marked to Chief Engineer, (MPT) will be opened at the time and date notified in the Tender Notice.
- 6.3 The Second cover i.e. "**Financial Bid**" of non-qualified bidders will be retained unopened and no correspondence on this decision will be entertained. The Second covers of only those tenderers, who are found to be eligible, will be opened later. The date and the time of opening the Second cover will be notified to the concerned tenderers and the Second cover will be opened in the presence of such of those tenderers who may wish to be present.

7. **VALIDITY PERIOD OF TENDERS**

- The validity period of the tender shall be 180 days after the submission of the Bid Offer. Tenders with a shorter validity period shall be rejected.
8. Tenderers should not send revised or amended offer after the closing day and the time of tender.
9. The contractor shall take special care to protect and support at their own cost the underground service like electrical cables, telephone cables, water-mains, drainage pipelines and other services lines etc. coming in the way of works. Damages if any will be at tenderer's cost.
10. Further clarification, if any, can be obtained from the Executive Engineer, (P&C Section) Engineering Civil Department, Mormugao Port Trust or by contacting the officer designated in the Tender Notice.
11. The tenderers are not allowed to fill in the tender or seal the tender in the MPT premises.

CHIEF ENGINEER
MORMUGAO PORT TRUST
MORMUGAO – GOA

Mormugao, Headland Sada.
Dated: 04/07/2016.



MORMUGAO PORT TRUST
ENGINEERING (CIVIL) DEPARTMENT

TENDER No. CE/55/2016

**Name of Work: PROVIDING SIGNALLING AND TELECOMMUNICATION
SYSTEM FOR RAILWAY NETWORK AT MORMUGAO PORT, GOA.**

(vii) - JOINT VENTURE

- 1 The number of members in the Joint Venture (JV) shall be restricted to two.
- 2 Lead member of the JV shall have equity share of minimum 51% and maximum 74%. Lead member shall satisfy Financial and Technical criteria specified in the tender.
- 3 Other member of JV shall satisfy Financial criteria specified in the tender. Other member of JV shall execute similar work not less than 15% of the estimated cost of tender value of work.
- 4 All the members of the joint venture shall be, jointly raise the finance whenever required and jointly responsible for the liability, during the bidding process and for the execution of the contract in accordance with the contract terms, and a statement to this effect shall be included in the authorization or memorandum of understanding or joint venture Agreement. The bid shall be signed so as to legally bind all the members, jointly or severally.
- 5 Bids submitted by a joint venture (JV) shall comply with the following requirements:
 - a) A copy of the Joint Venture Agreement (JVA) entered into by the partners shall be submitted with the bid. JVA shall include among other things, the Joint Venture's objectives, the proposed management structure, the contribution of each partner to the Joint Venture operation, the commitment of the partners to joint and several liability for due performance, recourse/ sanctions within the Joint Venture in the event of default or withdrawal of any partner and arrangements for providing the required indemnities.
 - b) The most experienced partner will be the Lead Partner and nominated as the partner- in-charge; in pursuance to Clause 2 and this authorisation shall be evidenced by submitting a power of attorney signed by the legally authorised signatories of all the partners. The

most experienced partner/Lead Partner will be the one defined as such in the communication approved the pre-qualification.

- c) The most experienced partner/Lead Partner of the joint venture will provide suitable experienced personnel at site for the purpose of general planning, site management and plant operations, during the whole period of contract execution and a statement to this effect should be included in the Joint Venture Agreement.
- d) The bid, and in the case of the successful bidder, the Form of Agreement shall be signed and / or executed in such a manner as may be required for making it legally binding on all partners (including operative parts of the ensuing Contract in respect of Arbitration Agreement etc.)
- e) The partner-in-charge shall be authorised to incur liabilities and to receive instructions for and on behalf of all partners of the Joint Venture and the entire execution of the Contract including payment shall be carried out exclusively through the partner-in-charge. A statement to this effect should be included in the joint venture agreement.
- f) All partners of the joint venture shall be liable jointly and severally for the execution of the Contract in accordance with the Contract terms, and a statement to this effect shall be included in the joint venture agreement.
- g) Bid Security (EMD) as required can be furnished by any partner but it should be in the name of joint venture.
- h) Performance guarantee, as required, will be furnished by all partner(s), out of their accounts, in proportion to their participation in Joint Venture.
- i) Joint Venture Agreement shall contain a clause to the effect that there shall be a separate JV Bank Account (distinct from the Bank Accounts of the individual partners) to which the individual partner shall contribute their share capital and / or working capital.
- j) Joint Venture Agreement shall also contain a clause to the effect that the financial obligations of the JV shall be discharged through the said JV Bank Account only and also all the payments received by the JV from the Employer shall be through that account alone.
- k) In the event of default by the most experienced partner (lead Partner), it shall be constructed as default of the Contractor; and Employer will take action under Conditions of Contract.

- l) In the event of any other partner leaving the JV, it shall be intimated to the Employer within 30 days by the other partner(s). Failure to do so shall be construed as default of the Contractor and the Employer may take action under the Conditions of Contract.
- m) In case the joint venture agreement is not acceptable to the Employer, the joint venture will modify the agreement so as to be acceptable to the Employer.
- n) The bid submitted shall include all the information as per the PROFORMA in the bid document and furnished separately for each partner.
- o) In case of withdrawal of any partner from the JV the following shall be applicable:
 - i) Stepping into the shoes of the existing partners of JV with all the liabilities of the existing partners from the beginning of the Contract;
 - ii) With the prior approval of the Employer;
 - iii) Notwithstanding demarcation or allotment of work between two JV partners, JV shall be liable for non-performance of the whole contract irrespective of their demarcation or share of work; and
 - iv) The payments under the contract will only be made to the JV and not to the individual partners.

JOINT VENTURE PARTNER INFORMATION FORM

[The Tenderer shall fill in this Form in accordance with the instructions indicated below].

Date: insert date (as day, month and year) of Tender Submission].

Tender No.: [insert number of Tendering process]

1.	Tenderer's Legal Name: [insert <i>Tenderer's legal name</i>]
2.	JV's Party Legal name: [<i>insert JV's Party legal name</i>]
3.	JV's Party Country of Registration: [<i>insert JV's Party country of registration and details of registration</i>]
4.	JV's Party Year of Registration: <i>Insert JV's Party year of registration</i>
5.	JV's Party Legal Address in Country/ of Registration: [<i>insert JV's Party legal address in country of registration</i>] JV's Party Authorized Representative Information Name: [insert name of JV's Party authorized representative]
6.	Address: [insert address of JV's Party authorized representative] Telephone/Fax numbers: [insert telephone/fax numbers of JV's Party authorized representative] Attached are copies of original documents of: [<i>check the box(es) of the attached original documents</i>] <ul style="list-style-type: none"><input type="radio"/> Articles of Incorporation or Registration of firm named in 2, above, in accordance with Tender Document<input type="radio"/> In case of government owned entity from India, documents establishing legal and financial autonomy and compliance with commercial law, in accordance with Tender Document<input type="radio"/> PAN Number<input type="radio"/> Sales Tax / VAT registration Number<input type="radio"/> Service Tax Registration Number<input type="radio"/> Any other documents required for statutory compliance

Duly authorized to sign this Authorization on behalf of: [*Insert complete name of Tenderer*]

Dated on _____ day of _____, _____ [*insert date of signing*]



MORMUGAO PORT TRUST
ENGINEERING (CIVIL) DEPARTMENT

TENDER No. CE/55/2016

(viii) FORM OF AGREEMENT

THIS AGREEMENT made this _____ day of _____ two thousand fifteen BETWEEN the Board of Trustees of the Port of Mormugao, a body corporate under the Major Port Trusts Act. 1963 (herein under referred to as “the Board” which expression shall unless repugnant to the context or meaning thereof mean and include their successors and assigns) of the ONE PART of M/s. _____, having their registered office at _____ (hereinafter referred to as “the contractor”, which expression shall unless repugnant to the context or meaning thereof, mean and include their heirs, executors, administrators, representatives and assignees or successors in office) of the OTHER PART.

WHEREAS the Board is desirous of executing the work of “ _____ ” on the terms and conditions stipulated in the contractor’s tender dated _____ and read with the conditions contained in the tender documents attached to the above mentioned tender.

AND WHEREAS the contractor by their above mentioned tender has offered to execute, complete and maintain such work, which tender has been accepted by the Board and such tender with correspondence, specifications, schedule. Amendments and acceptance thereof will constitute abiding contract between the Board and the contractor.

AND WHEREAS the contractor has furnished to the Board, a Bank Guarantee No. _____ dated _____ for a sum of Rs. _____ (Rupees _____)

_____ only) as Initial Security for the due performance and observance by the contractor of the terms and conditions of this Agreement.

NOW THIS AGREEMENT WITNESSETH AS FOLLOWS:

01. In this agreement words and expressions shall have the same meaning as are respectively assigned to them in the conditions of contract herein after referred to.
02. The following documents shall be deemed to form and be read and construed as part of this agreement.
 - (A) **COVER No. - I**
 - a. Contents of Tender Document
 - b. Undertaking by the Tenderer
 - c. Tender Notice
 - d. Clause of General Conditions of Contract.
 - e. Appendix I
 - f. Appendix II (Materials to be supplied by Department)
 - g. Appendix III (Estate rental)
 - h. Proforma 1, 2, 3, 4, 5 & 6
 - i. Instructions for preparation and submission of tender.
 - j. Joint Ventures
 - k. Additional special instructions.
 - l. Additional General Specification – Works in Traffic Block Condition
 - m. Phase working of MPT Railway Expansion Work
 - n. Scope of Work
 - p. Form of Bank Guarantee for EMD and Security Deposit and Form of Agreement (Annexures I & II)
 - q. Indicative Drawing No.
 - r. A printed set containing Instructions to tenderers, General and special conditions of contract. (VOLUME –I)

(B) **COVER No. II**

- i) Preamble to Schedule of Quantities and Rates
 - ii) Schedule of quantities and rates
 - iii) Tender Form
 - iv) Contractor's acceptance letter No. _____ dated _____.
 - iv) Any other relevant correspondence exchanged upto the issue of work order which has not been specifically mentioned above.
 - v) All additional drawings, specifications and written Instructions when issued by or approved in writing by the Chief Engineer as per clause No.9 of the General Conditions.
03. The contractor hereby covenants with the Board to construct, complete and maintain the work in conformity in all respects with the provisions of the contract.
04. The Board hereby covenants to pay to the contractor the contract price in consideration of the construction, completion and maintenance of the work, at the times and in the manner prescribed by the contract.
05. IN WITNESS WHEREOF THE PARTIES HAVE placed their hand and seals, the day, month, year first above written

THE COMMON SEAL OF THE TRUSTEES OF

THE PORT OF MORMUGAO HAS HEREUNTO

Affixed and the Chairman thereof Chief Engineer has hereunto set his hand in the presence of

1.

2.

Signed and sealed by the contractor In the presence of

1.

2.



MORMUGAO PORT TRUST
ENGINEERING (CIVIL) DEPARTMENT

TENDER No. CE/55/2016

(viii) FORM OF BANK GUARANTEE FOR SECURITY DEPOSIT

In consideration of the Board of Trustees of the Mormugao Port Trust (hereinafter called "The Board") having offered to accept the terms and conditions of the proposed agreement between _____ and _____ (hereinafter called "the said Contractor(s)" for the work _____(hereinafter called "the said agreement") having agreed to production of an irrevocable Bank guarantee for Rs. _____ (Rupees _____ only) as a security/guarantee from the Contractor(s) for compliance of his obligations in accordance with the terms and conditions in the said agreement.

1. We _____ (hereinafter referred to as the "Bank") hereby undertake to (indicate the name of the Bank) pay to the Board an amount not exceeding Rs. _____ (Rupees _____ only) on demand by the Board.

2. We _____ do hereby undertake to pay the amounts due and payable (indicate the name of the Bank) under this Guarantee without any demur, merely on a demand from the Board stating that the amount claimed is required to meet the recoveries due or likely to be due from the said Contractor(s). Any such demand made on the bank shall be conclusive as regards the amount due and payable by the Bank under this guarantee. However, our liability under this Guarantee shall be restricted to an amount not exceeding Rs. _____ (Rupees _____ only).

3. We, the said Bank, further undertake to pay to the Board any money so demanded notwithstanding any dispute or disputes raised by the Contractor(s) in any suit or proceeding pending before any Court or Tribunal relating thereto, our liability under this present being absolute and unequivocal. The payment so made by us

under this bond shall be a valid discharge of our liability for payment there under, and the Contractor(s) shall have no claim against us for making such payment.

4. We _____ further agrees that the Guarantee herein contained shall (indicate the name of the Bank) remain in full force and effect during the period that would be taken for the performance of the said agreement, and it shall continue to be enforceable till all the dues of the Board under or by virtue of the said agreement have been fully paid, and its claims satisfied or discharged, or till the Engineer-In-Charge, on behalf of the Board, certifies that the terms and conditions of the said agreement have been fully and properly carried out by the said Contractor(s), and accordingly discharges this Guarantee.

5. We _____ further agree with the Board that the Board (indicate the name of the bank) shall have the fullest liberty without our consent, and without effecting in any manner our obligations hereunder, to vary any of the terms and conditions of the said agreement or to extend time of performance by the said Contractor(s) from time to time or to postpone for any time or from time to time any of the powers exercisable by the Board against the said Contractor(s) and to forbear or enforce any of the terms and conditions relating to the said agreement, and we shall not be relieved from our liability by reason of any such variation or extension being granted to the said Contractor(s) or for any forbearance, act of omission on the part of the Board or any indulgence by the Board to the said Contractor(s) or by any such matter or thing whatsoever which under the law relating to sureties would, but for this provision, have effect of so relieving us.

6. This guarantee will not be discharged due to the change in the Constitution of the Bank or the Contractor(s).

7. We _____ lastly undertake not to revoke this Guarantee except with (indicate the name of the Bank) the previous consent of the Board in writing.

8. This Guarantee shall be valid upto _____ unless extended on demand by the Board. Notwithstanding anything mentioned above, our liability against this Guarantee is restricted to Rs. _____ (Rupees _____ only), and unless a claim in writing is lodged with us within six months of the date of expiry or extended

date of expiry of this Guarantee all our liabilities under this Guarantee shall stand discharged.

Dated the _____ day of _____ For _____

(indicate the name of the Bank)



MORMUGAO PORT TRUST
ENGINEERING (CIVIL) DEPARTMENT

TENDER No. CE/55/2016

**Name of Work: PROVIDING SIGNALLING AND TELECOMMUNICATION SYSTEM
FOR RAILWAY NETWORK AT MORMUGAO PORT, GOA.**

(x). SCOPE OF WORK

PART-I - Signalling and Telecommunication System

1. The proposed work comprises of providing microprocessor based equipment Electronic Interlocking (distributed) (EI) used for the operation of points, signals, level crossing gates, block working with adjacent station, releasing of crank handle for manual operation of points and other controls like slots etc. through a control cum indication panel or VDU based control panel.
2. It shall be possible to interface more than CCIP or VDU control terminal. For the purpose of this specification, the terminology given in latest version of IRS: S 23 and RDSO/SPN/ 144/2014 shall apply.

PART-II - Signalling and Telecommunication System during Maintenance Period Including Free Maintenance Period

1. The contractor shall be entirely responsible for maintaining the Port's Railway Signalling and Telecommunication System and ensure it to be working at all times.
2. The contractor shall deploy three persons per shift in three shifts including on Sundays and holidays for round the clock for maintenance of the Railway Signalling and Telecommunication System. These persons should be available at the work spot at all times to monitor the condition and to attend to breakdowns and other routine maintenance works. The deployed persons should have experience of more than 3 years in railway signalling and telecommunication installation and maintenance. The shift reports of all three shifts are to be submitted to MPT Engineer at the end of the shift.

3. The contractor or his authorized representative of higher capacity viz. Supervisor who can take decision on the spot shall be available at the work place during office hours and should take decisions on the spot in all matters reported to him by the Engineer and should also inform MPT personnel (in-charge). He should also be available on mobile during remaining hours of the day for taking decision in case of any eventuality.
4. The period of AMC in the subject tender is three years after completion of maintenance period and annual extension will be subject to performance at each of the completed years.
5. Signalling maintenance and failure registers are to be maintained by contractor periodically. The register shall indicate date and time of problem noticed, failure details, how the rectification is done, replacement card particulars, defective card particulars, date and time of rectification. The contractor or his authorized Engineer/ representative has to sign the register and countersign of the MPT representative shall be taken.
6. Regular inspection of point machines, Verification of Track Locking, Track circuit continuity and proper bonding, Track Gauge, condition of stretcher bar bolts, connecting rod bolts, etc, is to be done and the same is to be maintained to required standards. The details of preventive checks shall also be entered in the register with the signature of the contractor or his authorized Engineer/ representative and MPT representative.
7. The register shall be maintained in the following format:

S. No.	Date & Time of reporting failure	Type of failure	Date & Time of rectifying failure	How the rectification is done	Sl. No. of the defective card	Sl. No. of the replacement card	Delay in attending breakdown (hour)	Signature of contractor	Signature of MPT representative

8. Regular inspection of track circuit chargers, Batteries etc is to be done. Track potential to be maintained properly and proper functioning (pick up/drop) of Track relay is to be ensured.
9. Proper functioning of all indications and selector switches at the Panel Room is to be ensured.
10. All safety related interlocking to be checked and properly maintained.

11. All the battery chargers and batteries are to be monitored regularly and topping up of distilled water in batteries is to be done as and when required.
12. Meggering of Cables is to be done, the records to be maintained and submitted. If Low Insulation value is found, it must be brought to the notice of concerned MPT officials for immediate rectification.
13. Any breakdown has to be attended to within 2 hours. The delay beyond specified completion period is subject to levy of penalty of Rs.750/- per hour for first day and Rs.1,500/- per hour from next day onwards till work is completed.
14. Vegetation growth around the location boxes, battery boxes, point machines, track load junction boxes, etc shall be periodically cleared and the space around the installation shall be kept clean at all times.
15. The consumables and miscellaneous items shall be arranged by contractor at his own cost.
16. Any other Signalling maintenance work necessary for smooth operation of panel and points, will have to be done by the contractor.
17. The contractor's engineers shall carry the routine spares required for preventive maintenance to ensure minimum down time.
18. Joint inspections of the Motorised points and carrying out of 'Obstruction test' for normal and reverse along with the Port's engineer must be done periodically with prior intimation and the same should be recorded in a 'Joint Inspection Register'.
19. Relay Room must be provided with double key lock system, and one of the key must be kept under the custody of Panel Master on duty, and whenever required Technician may collect the key after making proper entries in the available register.
20. In case of failure reported which involves other Departments written intimation may be given and if required joint test may be conducted to rectify the same.
21. In case of emergencies, the addition and alternations done to the existing installations and circuits to be recorded and shall be reported the same to the Chief Mechanical Engineer/MPT in writing and obtain necessary post facto approval.
22. The visibility of the signals should be checked periodically.

23. Earth may be tested by means of Earth Tester and same must be exhibit on the location boxes and relay room walls. (Ordinary Earth less than 10 ohms and Chemical Earth less than 1 ohms to be maintained.)
24. Ensure the availability of correct rating fuses for all the circuits inside relay room, power panel and location boxes.
25. Crank handle must be interlocked with circuits and kept sealed inside the glass front boxes and ensure the counter after every release and make entries in available registers.
26. Proper identification card / Muster sheets for the staff those who are working in the yard must be issued and whenever asked to be produced.
27. Oiling and lubrication of points to be done once in a month. The oil and lubricant will be supplied by the port.
28. Power supply failures or fluctuations are required to be given immediate attention.
29. Signalling Equipment which requires painting should be painted by the contractor based on the joint inspection report. Paint will be supplied by Port. The work is required to be carried out strictly as per relevant Indian Railway Standards, RDSO Specification; the Drawings and as described in Specifications and Schedule of Quantities and Rates contained in this tender document with approved quality of materials.

The above works in Part I and II shall be carried out under the supervision and to the entire satisfaction of the Chief Mechanical Engineer or his representative.



MORMUGAO PORT TRUST
ENGINEERING (CIVIL) DEPARTMENT

TENDER No. CE/55/2016

**Name of Work: PROVIDING SIGNALLING AND TELECOMMUNICATION SYSTEM
FOR RAILWAY NETWORK AT MORMUGAO PORT, GOA.**

(xi) ADDITIONAL SPECIAL INSTRUCTIONS

1. Tenderers are required to sign with date the Schedule of Quantities and Rates and the form of tender and fill in all the particulars and details called for therein. Unsigned tenders, without the details called for are liable for rejection.
2. **Measurements**
The quantities provided for in the Schedule of Quantities and Rates are only approximate and are given to provide a common basis for tendering. The actual quantity may differ from those provided for in the Schedule in view of the special and complex nature of the work. Payments will be made according to the actual quantities of work ordered and carried out, jointly measured by the representative of Chief Engineer and the contractor.
3. **Rates and Prices to be inclusive.**
The rates entered in the Schedule of Quantities by the tenderer shall include the provision of all supporting special equipment, labour of required skill, supervision, materials, overheads and profits, watch and ward, insurance charges, during execution and every incidental and contingent costs and charges, whatsoever, including sales tax on works contracts, Entry tax, etc. if any, for compliance with conditions of contract and specification. **Service tax is applicable as per relevant provisions of the act time to time and shall be paid extra.**
4. The tenderer shall inspect the site and fully study the work involved vis-à-vis the specifications etc. before tendering for the work.
5. Any damage to the property of Port should be made good or compensated by the contractor.
6. After completion of the days, work / contract period the contractor shall clean, clear the work site to the satisfaction of the Chief Engineer or his site representative.
7. Permission for working beyond the normal working hours of the Port or on Sundays and Public Holidays as stipulated under Clause No.43 of the General Conditions of Contract, Volume – I of the tender document will be given to the contractor subject to his agreeing to bear the cost of overtime, if any, which may have to be paid to the Port's supervisory staff.

8. The contractor and his workers / agents shall be required to obtain from MPT and display a Photo Identity Card during entry, stay and exit from the Port security areas guarded by CISF personnel.
9. All applications for issuance of Photo Identity cards shall be routed through the Chief Engineer, who shall forward the same to the Port's Traffic Department, whose pass section will issue the Photo Identity Card to the contractor or his agents on payment of necessary fees as prescribed from time to time and the same shall be valid for the duration of the contract or a period of one year, whichever is less. Application form and prescribed fees for Harbour Entry Permit (HEP) as indicated in **Annexure 'B'**.
10. Subject to the availability, land for construction of temporary sheds/stores/labour hutments, etc. will be given to the contractor in Port areas at Headland. The contractor shall clear away all the temporary structures built within a period of fourteen days after completion of the work and leave the whole of the site clean to the satisfaction of the Chief Engineer. In case the contractor fails to vacate the Port area / premises allotted to him for site office / store within the stipulated period after the completion of the work, the Board shall have the right to debar such defaulting contractors for future contracts of the Board by blacklisting him and shall also be charged penal lease rental at the prescribed rates.
11. Lease rent shall be charged to the contractors for the area allotted for construction of their temporary sheds for site office/store/labour hutments required in the contract works. The licence fee shall be as per Port's scale of Rates vide item (i) and (ii) of Part - I (Appendix-III).
12. No temporary structures/sheds which are constructed to house the contractor's office/store/labour hutments shall be permitted to be retained during the period of maintenance.
13. All the materials to be used in the structure shall be conforming to relevant ISI specifications or as specified in the Tender Schedule. Contractor shall undertake laboratory test as specified in the relevant I.S.I. at the discretion of Chief Engineer and only approved materials/approved brand of materials shall be used.
14. Electrical power and water required for the work shall be supplied as per the availability at the Port's Scale of Rates vide Item No. I & II of Part - I (Appendix - II).
15. Contractor may submit the following information in order to refund the EMD'S, BG'S/SECURITY DEPOSITS/ RETENTION MONEY, payment of bill's etc.
 - a. NAME OF BANK
 - b. PLACE
 - c. ACCOUNT No.
 - d. TYPE OF A/C No.
 - e. MICR / RTGS / IFS No.
 - f. Permanent Account Number

16. SITE REGISTERS:-

The contractor shall maintain following registers at Site, which shall be entered on day to day basis and produced on demand.

1. Daily Register works with labour deployed at site.
2. Hindrance Register.
3. Site Instruction Book.
4. Joint Record / Measurement Register.
5. Labour Register with payment of wages.
6. Any other register required by the Chief Mechanical Engineer or his representative.

The Contractor shall keep all registers in safe custody.

17. Contractor shall have to survey the proposed alignment as per the drawing issued and prepare detailed drawing showing cable route, position of junction boxes, battery boxes, etc. and any other working drawing required, if any, for the execution of work as directed by the Chief Mechanical Engineer or his representative. Approval of all such drawings shall be obtained before commencement of the work from PMC Consultants.
18. During execution of work for each Traffic block condition, contractor shall submit detailed program of traffic block conditions, along with the details for the approval of the Traffic Manager/ Chief Mechanical Engineer through PMC Consultants.
19. On completion of the work, 'As BUILT DRAWINGS' shall be submitted within 30 days in soft form on Compact Disk (CD) and also in hard copy on tracing paper. Approval of all such drawings shall be obtained from PMC Consultants within 15 days.
20. Contractor shall also liaison with South Western Railway Officials as and when required.
21. All precautions to ensure safety of workmen must be taken while unloading & loading the materials during execution of work. Traffic rules should be strictly followed to avoid accidents & unforeseen incidents.
22. The contractor must ensure the safety of labourers engaged by him while crossing the track during the course of execution of work & the Port will not be responsible for any injury sustained by the labourer or for any fatal accident. The contractor should bear all the loss & expenditure involved. Wherever necessary he should also provide necessary look out men.
23. During the course of execution of work if any underground /overhead or any other cable/OFC are damaged by the contractor or his labour etc., purely due to the default of the contractor, the cost of damage, as decided by the Port Administration will have to borne by the contractor.
24. Before taking up any digging work, it is the responsibility of the contractor to get cable layout plan from Chief Mechanical Engineer or his representative of the work & arrange to demarcate at the same at the site. The contractor shall take special precaution while carrying out works at location where there is

likelihood of any underground cables/OFC etc., & the work shall not be carried out without the presence of an authorized Port supervisor/ PMC Consultant.



xii) PROFORMA OF PRE CONTRACT INTEGRITY PACT

General

This pre-bid pre-contract Agreement (hereinafter called the Integrity Pact) is made on _____ day of the month of _____ 2016, between, on one hand, the Board of Trustees of Mormugao Port Trust acting through Shri. _____, (Designation of the Officer), Mormugao Port Trust (hereinafter called the 'EMPLOYER', which expression shall mean and include, unless the context otherwise requires, his successors in office and assigns) of the First Part and M/s. _____ represented by Shri. _____, Chief Executive Officer (hereinafter called the "BIDDER" which expression shall mean and include, unless the context otherwise requires, his successors and permitted assigns) of the Second Part.

WHEREAS the 'EMPLOYER' has invited bids for the project of **“PROVIDING SIGNALLING AND TELECOMMUNICATION SYSTEM FOR RAILWAY NETWORK AT MORMUGAO PORT, GOA.”** (hereinafter referred to as the **“Project”**) and the BIDDER is submitting his bid for the project and

WHEREAS the BIDDER is a Private Limited company/Public Limited company/Government undertaking/registered partnership firm/ constituted in accordance with the relevant law in the matter and the 'EMPLOYER' is Mormugao Port Trust.

NOW, THEREFORE,

To avoid all forms of corruption by following a system that is fair, transparent and free from any influence/prejudiced dealings prior to, during and subsequent to the currency of the contract to be entered into with a view to:-

Enabling the EMPLOYER to obtain the desired said stores/equipment/ services/works at a competitive price in conformity with the defined specifications by avoiding the high cost and the distortion impact of corruption on public procurement, and

Enabling BIDDERS to abstain from bribing or indulging in any corrupt practice in order to secure the contract by providing assurance to them that their competitors will also abstain from bribing and other corrupt practices and the 'EMPLOYER' will commit to prevent corruption, in any form, by its officials by following transparent procedures.

The parties hereto hereby agree to enter into this Integrity Pact and agree as follows:

Commitments of the 'EMPLOYER'

- 1.1 The 'EMPLOYER' undertakes that no official of the 'EMPLOYER', connected directly or indirectly with the contract, will demand, take a promise for or accept, directly or through intermediaries, any bribe, consideration, gift, reward, favour or any material or immaterial benefit or any other advantage from the BIDDER, either for themselves or for any person, organisation or third party related to the contract in exchange for an advantage in the bidding process, bid evaluation, contracting or implementation process related to the contract.
- 1.2 The 'EMPLOYER' will, during the pre-contract stage, treat all BIDDERS alike and will provide to all BIDDERS the same information and will not provide any such information to any particular BIDDER which could afford an advantage to that particular BIDDER in comparison to other BIDDERS.
- 1.3 All the officials of the 'EMPLOYER' will report to the appropriate Government office any attempted or completed breaches of the above commitments as well as any substantial suspicion of such a breach.
2. In case any such preceding misconduct on the part of such official(s) is reported by the BIDDER to the 'EMPLOYER' with full and verifiable facts and the same is prima facie found to be correct by the 'EMPLOYER' necessary disciplinary proceedings, or any other action as deemed fit, including criminal proceedings may be initiated by the 'EMPLOYER' and such a person shall be debarred from further dealings related-to the contract process. In such a case while an enquiry is being conducted by the 'EMPLOYER' the proceedings under the contract would not be stalled.

Commitments of BIDDERS

3. The BIDDER commits itself to take all measures necessary to prevent corrupt practices, unfair means and illegal activities during any stage of its bid or during any pre-contract or post-contract stage in order to secure the contract or in furtherance to secure it and in particular commit itself to the following:-
 - 3.1 The BIDDER will not offer, directly or through intermediaries, any bribe, gift, consideration, reward, favour, any material or immaterial benefit or other advantage, commission, fees, brokerage or inducement to any official of the 'EMPLOYER' connected directly or indirectly with the bidding process, or to any person, organisation or third party related to the contract in exchange for any advantage in the bidding, evaluation, contracting and implementation of the contract.
 - 3.2 The BIDDER further undertakes that it has not given, offered or promised to give, directly or indirectly any bribe, gift, consideration, reward, favour, any material or immaterial benefit or other advantage, commission, fees, brokerage or inducement to any official of the 'EMPLOYER' or otherwise in procuring the Contract or forbearing to do or having done any act in relation to the obtaining or execution of the contract or any other contract with the Government for showing or forbearing to show favour or disfavour to any person in relation to the contract or any other contract with the Government.
 - 3.3* BIDDERS shall disclose the name and address of agents and representatives and Indian BIDDERS shall disclose their foreign principals or associates.
 - 3.4* BIDDERS shall disclose the payments to be made by them to agents/brokers or any other intermediary, in connection with this bid/contract.
 - 3.5* The BIDDER further confirms and declares to the 'EMPLOYER' that the BIDDER has not engaged any individual or firm or company whether Indian or foreign to intercede, facilitate or in any way to recommend to the EMPLOYER or any of its functionaries, whether officially or unofficially to the award of the contract to the BIDDER, nor has any amount been paid, promised or intended to be paid to any such individual, firm or company in respect of any such intercession, facilitation or recommendation.

- 3.6 The BIDDER, either while presenting the bid or during pre-contract negotiations or before signing the contract, shall disclose any payments he has made, is committed to or intends to make to officials of the 'EMPLOYER' or their family members, agents, brokers or any other intermediaries in connection with the contract and the details of services agreed upon for such payments.
- 3.7 The BIDDER will not collude with other parties interested in the contract to impair the transparency, fairness and progress of the bidding process, bid evaluation, contracting and implementation of the contract.
- 3.8 The BIDDER will not accept any advantage in exchange for any corrupt practice, unfair means and illegal activities.
- 3.9 The BIDDER shall not use improperly, for purposes of competition or personal gain, or pass on to others, any information provided by the 'EMPLOYER' as part of the business relationship, regarding plans, technical proposals and business details, including information contained in any electronic data carrier. The BIDDER also undertakes to exercise due and adequate care lest any such information is divulged.
- 3.10 The BIDDER commits to refrain from giving any complaint directly or through any other manner without supporting it with full and verifiable facts.
- 3.11 The BIDDER shall not instigate or cause to instigate any third person to commit any of the actions mentioned above.
- 3.12 If the BIDDER or any employee of the BIDDER or any person acting on behalf of the BIDDER, either directly or indirectly, is a relative of any of the officers of the 'EMPLOYER' or alternatively, if any relative of an officer of the 'EMPLOYER' has financial interest/stake in the BIDDER's firm, the same shall be disclosed by the BIDDER at the time of filing of tender.
- The term 'relative' for this purpose would be as defined in Section 6 of the Companies Act 1956.
- 3.13 The BIDDER shall not lend to or borrow any money from or enter into any monetary dealings or transactions, directly or indirectly, with any employee of the 'EMPLOYER'.

4. Previous Transgression

- 4.1 The BIDDER declares that no previous transgression occurred in the last three years immediately before signing of this Integrity Pact, with any other company in any country in respect of any corrupt practices envisaged hereunder or with any Public Sector Enterprise in India or any Government Department in India that could justify bidder's exclusion from the tender process.
- 4.2 The BIDDER agrees that if it makes incorrect statement on this subject, BIDDER can be disqualified from the tender process or the contract, if already awarded, can be terminated for such reason.

5. Earnest Money (Security Deposit)

- 5.1 While submitting commercial bid, the BIDDER shall deposit an amount _____ (to be specified in Bid Document) as Earnest Money/Security Deposit, with the 'EMPLOYER' through any of the following instruments:
- (i) Bank Draft or a Pay Order in favour of _____
 - (ii) A confirmed guarantee by an Indian Nationalised Bank, promising payment of the guaranteed sum to the 'EMPLOYER' on demand within 3 working days without any demur whatsoever and without seeking any reasons whatsoever. The demand for payment by the 'EMPLOYER' shall be treated as conclusive proof of payment.
 - (iii) Any other mode or through any other instrument (to be specified in the Bid Document).
- 5.2 The Earnest Money/Security Deposit shall be valid up to a period of _____ months or the complete conclusion of the contractual obligations to the complete satisfaction of both the BIDDER and the EMPLOYER, including warranty period, whichever is later.
- 5.3 In case of the successful BIDDER, a clause would also be incorporated in the Article pertaining to Performance Security in the Project Contract that the provisions of Sanctions for Violation shall be applicable for forfeiture of Performance Security in case of a decision by the EMPLOYER to forfeit the same without assigning any reason for imposing sanction for violation of this Pact.

- 5.4 In case of the successful BIDDER a clause would also be incorporated in the Article pertaining to Performance Bond in the Purchase Contract that the provisions of Sanctions for violation shall be applicable for forfeiture of Performance Bond in case of a decision by the BUYER to forfeit the same without assigning any reason for imposing sanction for violation of this Pact.
- 5.5 No interest shall be payable by the 'EMPLOYER' to the BIDDER on Earnest Money/Security Deposit for the period of its currency.

6. **Sanctions for Violations**

- 6.1 Any breach of the aforesaid provisions by the BIDDER or any one employed by it or acting on its behalf (whether with or without the knowledge of the BIDDER) shall entitle the 'EMPLOYER' to take all or any one of the following actions, wherever required:-

(i) To immediately call off the pre contract negotiations without assigning any reason or giving any compensation to the BIDDER. However, the proceedings with the other BIDDER(s) would continue.

(ii) The Earnest Money Deposit (in pre-contract stage) and/or Security Deposit/Performance Bond (after the contract is signed) shall stand forfeited either fully or partially, as decided by the 'EMPLOYER' and the 'EMPLOYER' shall not be required to assign any reason therefore.

(iii) To immediately cancel the contract, if already signed, without giving any compensation to the BIDDER.

(iv) To recover all sums already paid by the BUYER, and in case of an Indian BIDDER with interest thereon at 2% higher than the prevailing Prime Lending Rate of State Bank of India, while in case of a BIDDER from a country other than India with interest thereon at 2% higher than the LIBOR. If any outstanding payment is due to the BIDDER from the BUYER in connection with any other contract for any other stores, such outstanding payment could also be utilized to recover the aforesaid sum and interest.

(v) To encash the advance bank guarantee and performance bond/warranty bond, if furnished by the BIDDER, in order to recover the payments, already made by the EMPLOYER, along with interest.

- (vi) To cancel all or any other Contracts with the BIDDER. The BIDDER shall, be liable to pay compensation for any loss or damage to the 'EMPLOYER' resulting from such cancellation/rescission and the 'EMPLOYER' shall be entitled to deduct the amount so payable from the money(s) due to the BIDDER.
- (vii) To debar the BIDDER from participating in future bidding processes of the Government of India for a minimum period of five years, which may be further extended at the discretion of the 'EMPLOYER' or take action as per the procedure mentioned in the "Guidelines on Banning of Business dealings." Copy of the Guidelines on Banning of business dealings" is annexed and marked as Annexure.
- (viii) In cases where irrevocable Letters of Credit have been received in respect of any contract signed by the EMPLOYER with the BIDDER, the same shall not be opened.
- (ix) To recover all sums paid in violation of this Pact by BIDDER(s) to any middleman or agent or broker with a view to securing the contract.
- (x) Forfeiture of Performance Guarantee in case of a decision by the 'EMPLOYER' to forfeit the same without assigning any reason for imposing sanction for violation of this Pact.
- 6.2 The 'EMPLOYER' will be entitled to take all or any of the actions mentioned at para 6.1(i) to (x) of this Pact also on the Commission by the BIDDER or any one employed by it or acting on its behalf (whether with or without the knowledge of the BIDDER), of an offence as defined in Chapter IX of the Indian Penal code, 1860 or Prevention of Corruption Act, 1988 or any other statute enacted for prevention of corruption.
- 6.3 The decision of the 'EMPLOYER' to the effect that a breach of the provisions of this Pact has been committed by the BIDDER shall be final and conclusive on the BIDDER. However, the BIDDER can approach the Independent Monitor(s) appointed for the purposes of this Pact.

7. **Failure Clause**

- 7.1 The BIDDER undertakes that it has not performed/is not performing similar project at a price lower than that offered in the present bid in respect of any other Ministry/Department of the Government of India or PSU and if it is found at any stage that similar project was performed by the BIDDER to any other Ministry/Department of the Government of India or a PSU at a lower price, then that very price, with due allowance for elapsed time, will be applicable to the present case and the difference in the cost would be refunded by the BIDDER to the 'EMPLOYER', if the contract has already been concluded.

8. **Independent Monitors**

- 8.1 The 'EMPLOYER' has appointed the following Independent Monitors (hereinafter referred to as Monitors) for this Pact in consultation with the Central Vigilance Commission.

Shri AJIT RAIZAD, Retd. IAS

- 8.2 The task of the Monitors shall be to review independently and objectively, whether and to what extent the parties comply with the obligations under this Pact.
- 8.3 The Monitors shall not be subject to instructions by the representatives of the parties and perform their functions neutrally and independently.
- 8.4 Both the parties accept that the Monitors have the right to access all the documents relating to the project/bidding, including minutes of meetings.
- 8.5 As soon as the Monitor notices, or has reason to believe, a violation of this Pact, he will so inform the Authority designated by the EMPLOYER,
- 8.6 The BIDDER(s) accepts that the Monitor has the right to access without restriction to all Project documentation of the EMPLOYER, including that provided by the BIDDER. The BIDDER will also grant the Monitor, upon his request and demonstration of a valid interest, unrestricted and unconditional access to his project documentation. The same is applicable to Subcontractors. The Monitor shall be under contractual obligation to

treat the information and documents of the BIDDER/Subcontractor(s) with confidentiality.

- 8.7 The EMPLOYER, will provide to the Monitor sufficient information about all meetings among the parties related to the Project provided such meetings could have an impact on the contractual relations between the parties. The parties will offer to the Monitor the option to participate in such meetings.
- 8.8 The Monitor will submit a written report to the designated Authority of EMPLOYER within 8 to 10 weeks from the date of reference or intimation to him by the EMPLOYER/ BIDDER and, should the occasion arise, submit proposals for correcting problematic situations.

9. Facilitation of Investigation

In case of any allegation of violation of any provisions of this pact or payment of commission, the EMPLOYER or its agencies shall be entitled to examine all the documents including the Books of Accounts of the BIDDER and the BIDDER shall provide necessary information and documents in English and shall extend all possible help for the purpose of such examination.

10. Law and Place of Jurisdiction

This Pact is subject to Indian Law.' The place of performance and jurisdiction is the seat of the EMPLOYER

11. Other Legal Actions

The actions stipulated in this Integrity Pact are without prejudice to any other legal action that may follow in accordance with the provisions of the extant law in force relating to any civil or criminal proceedings.

12. Validity

- 12.1 The validity of this Integrity Pact shall be from date of its signing and extend up to 5 years or the complete execution of the contract to the satisfaction of both the EMPLOYER and the BIDDER, including warranty period, whichever is later. In case BIDDER is unsuccessful, this Integrity Pact shall expire after six months from the date of the signing of the contract.

12.2 Should one or several provisions of this Pact turn out to be invalid; the remainder of this Pact shall remain valid. In this case, the parties will strive to come to an agreement to their original intentions.

12.3 If the BIDDER is a partnership or a consortium, this agreement must be signed by all partners or consortium members.

13. The parties hereby sign this Integrity Pact at _____ on _____

EMPLOYER

BIDDER.

Name of the Officer.

CHIEF EXECUTIVE OFFICER

Designation

Deptt./MINISTRY/PSU

Witness

Witness

1. _____

1. _____

2. _____

2. _____,

* Provisions of these clauses would need to be amended/ deleted in line with the policy of the EMPLOYER in regard to involvement of Indian agents of foreign bidders.



MORMUGAO PORT TRUST
ENGINEERING (CIVIL) DEPARTMENT

TENDER No. CE/55/2016

**Name of Work: PROVIDING SIGNALLING AND TELECOMMUNICATION SYSTEM
FOR RAILWAY NETWORK AT MORMUGAO PORT, GOA.**

(xiii) CONDITIONS DURING ANNUAL MAINTENANCE CONTRACT

i) Taking over of the Signalling System:

Mormugao Port Trust (MPT) will take over the signalling system after the successful tenderer has commissioned the signalling system after carrying out the following test/trials.

1. Operational trials of signalling system for shunting operations of the port and will be tested to the satisfaction of the MPT & Consultant as per standards specified in the tender.
2. Endurance test: Endurance Test for 24 hrs, continuous shunting operation without any failure in three phases of 8 hrs shall be taken before handing over the signalling system to MPT.
3. The above said trials shall be at the sole expense and risk of the contractor who shall pay and discharge all costs and bear all liabilities of whatever kind arising out of the same. The contractor shall make good any damage which may arise in consequent thereof and indemnify the Board and the Chief Engineer and their respective officers and servants there from and from all claims, action, suits and proceedings and all costs, charges and expenses in respect thereof or in any way arising there from or incidental thereto.
4. After commissioning of the signalling system the successful tenderer will have to impart training to MPT's traffic and technical staff regarding the operations of the signaling system at MPT's site to attain the required skill.

ii) GUARANTEE PERIOD AND SATISFACTORY OPERATION:

1. The successful tenderer shall provide free of cost maintenance of the signalling system during guarantee period of 1 year(12 months). The maintenance during guarantee period covers all repairs including replacement of worn out/un-repairable components by new spares. The successful tenderer shall deploy his Technical Representative and staff for carrying out maintenance of the signalling system during 1 year Guarantee period. The staff deployed shall be available 24 hrs x 7 days and shall be

able to liaise with the representatives of Engineering Civil and Mechanical Engineering Department.

2. During the guarantee period, the successful tenderer shall post adequate skilled staff and supervising engineers as provided in the scope of work to ensure that running maintenance including rectification of fault/defects noticed during operation to the satisfaction as per the tender requirements. The successful tenderer shall arrange all tools, tackles and precision instruments for carrying out the repair/maintenance work.
3. The guarantee shall be enforceable from the date of taking over of the Signalling System. The successful tenderer shall be responsible for any defects that may develop under proper use arising from inferior materials, faulty design and poor workmanship in the work but not otherwise and shall at his own cost remedy such defects when called upon to do so by the Client / Site engineer.
4. 10% spares available with the Port as insurance spares shall be used by the successful tenderer as and when required during the guarantee period and AMC period of 3 years. These spares will be in the custody of Traffic Department of the Port. The successful bidder shall replace spares used for maintenance during Guaranty period within a month period.
5. During the guarantee period if any of the spares from stock provided by the port for the signalling system is used by the successful tenderer, the same shall be replenished within reasonable period. On completion of guarantee period complete inventory of spares supplied with signalling system should be available for AMC. The spares used by the successful tenderer from the Port stock and after replenished the same, the cost of the replenished items shall be paid by Port at actual.
6. Procurement, stocking and use of maintenance spares as well as consumables like lubricating oil, greases, electric LED signal lamps/ luminaries /chokes, cotton waste, kerosene/petrol etc. required for satisfactory performance during guarantee period is the responsibility of successful tenderer.
7. During the guarantee, successful tenderer has to give assured availability of signalling system not be less than 97% of total hours per month. However, if requisite availability of 97% is not achieved, the successful tenderer has to pay penalty as stated below:
8. Any breakdown has to be attended to within 2 hours. The delay beyond specified completion period is subject to levy of penalty of Rs.750/- per hour for first day and Rs.1,500/- per hour from next day onwards till work is completed.
9. The successful tenderer shall review quantity in stock and adequacy of spares at the end of guarantee period and arrange to procure the required spares and maintain the stock throughout the AMC period of 3 years.
10. The Guarantee period also includes the preventive maintenance to be carried out by the contractor as per the schedule of maintenance of the manufacturer, which is inclusive of spare parts & consumable required for maintenance at his cost.

11. The Maintenance schedule of 12 days in a year subject to approval of the Chief Mechanical Engineer, looking into cargo operation and decision given for signalling system under maintenance will be at Employer's discretion. However, the contractor shall carry out maintenance of signalling system in idle hours also. During these 12 days maintenance period will not be considered as a penalty and this left out maintenance period at the end of each year will not be carried forward to the next year and it will be lapsed. This maintenance 12 days period will be applicable during guarantee period and AMC Period also but it is only for carrying out scheduled preventive maintenance and not for break down maintenance during the guarantee period.
12. In the event the contractor fails to make available the signalling system due to any defect, the free time period for breakdown maintenance shall be as under:

Period	Type of break down	Free period Per year
For the 1year Guarantee period and 3 years AMC period	Minor	1 day
	Major	5 days

13. The type of break down as “minor” or “major” shall be decided by Chief Mechanical Engineer, MPT and the decision shall be binding on the contractor. If the defect is not rectified within the said free periods as above there will be a penalty as per Clause (7) above ‘Guarantee Period and satisfactory operation’ thereafter. The day will be reckoned from morning 7.30 AM to next day 7.30 AM for the above purpose.
14. The Employer shall give notice to the Contractor stating the nature of any such defects together with all available evidence thereof, promptly following the discovery thereof. The Employer shall afford all reasonable opportunity for the Contractor to inspect such defects.
15. Upon receipt of such notice, the Contractor shall within the period specified by MPT, expeditiously repair or replace the defective goods or parts thereof, at no cost to the Employer.

iii). ANNUAL MAINTENANCE CONTRACT (AMC):

1. After successful completion of the guarantee period of 1 year(12 months), the successful tenderer shall have to enter into Annual Maintenance Contract (AMC) for the next successive 3 years on review of performance every year and accordingly, the Tenderer has to quote the charges as per Schedule of Rates for the Annual Maintenance Contract. This Annual Maintenance Contract (AMC) covers all repairs including replacement of worn-out/un-repairable components and consumables at bidders cost. Successful tenderer's technical representatives duly skilled and qualified supervisor should be present 24x7 and on all days at MPT site, during the entire maintenance contract period of 3 years.

2. The successful tender shall be responsible for replacement of spares required for maintenance/ faulty spares/components from the insurance spares available with the Port and to be replenished by the successful tenderer on consumption at actual cost and consumables during the tenure of Guarantee period and AMC period is the responsibility of the contractor.
3. The successful tender shall be responsible for sufficient stock of necessary spares required during the preventive, breakdown maintenance shall be included in the AMC.
4. Successful tenderer shall carry out all Preventive Maintenance as the Manufacturers Service Schedule/Maintenance plan. The Maintenance shall be carried out as per the Manufacturers standard procedure and according to the instruction manuals. The entire components have to be cleaned externally and internally by proper means, at least once in a month or as per the periodicity prescribed by the standards.
5. Successful tenderer has to keep and submit all records of the daily/preventive/breakdown inspection and maintenance of signalling system at the end of each month as required by the MPT.
6. Recognize that all the assets covered under AMC system, tools, test equipments, manuals and other documents which are handed over to MPT while taking over/handing over, will be the property of the owners and not to dispose without the approval of the owner or any of the properties of the owner, unless such property shall be of no material value and not required for the AMC.
7. The Chief Mechanical Engineer or his representative will review to update maintenance plans periodically and intimate contractor accordingly.
8. As per requirement, calibrate and set meters, safety devices, protection devices, measuring instruments, gauges etc. periodically to ensure accuracy.
9. Make the signalling system available timely for inspection by owner or other competent authorities.
10. Critical Spares shall be restored to original level at the time of completion of AMC or termination due to unsatisfactory performance.
11. Assets handed over during AMC shall revert back to owner free of cost, subject to normal wear and tear.
12. The successful tenderer shall engage duly qualified team (skilled and unskilled) etc, required for carrying out maintenance comprising of at least one qualified engineer apart from others. The successful tenderer has to post enough staff so that the signalling system is looked after properly

round the clock, the employer has got the right to request the successful tenderer to increase the staff if not found sufficient. The contract Engineer will report to the Engineer In -Charge for day to day activity.

13. The responsibility of contractor during AMC includes procurement, stocking and use of maintenance spares as well as consumables required for satisfactory performance.
14. **DEFINITION:** The annual maintenance contract means that the successful tenderer has to carry out preventive maintenance of signalling system and accessories (as per the manufacturers schedule) and breakdown maintenance if any, inclusive use of spares provided by Port from insurance spares and replenishment of consumed spares to maintain the original level and labour, as per the quoted cost for 3 (three) years from the date of satisfactory completion of the guarantee period of 1 (one) year.
15. The rate for the AMC shall be quoted in Indian Rupees as in the Price Bid during the guarantee period and for 3 years from the time of commencement of AMC and remain frozen and will not be subject to any escalation for any reason whatsoever.
16. The Employer may extend the contract for further period of one year on the same terms and conditions at the sole discretion. In such case Successful tenderer shall extend the validity period of Bank Guarantee for further one year.
17. **CONTRACT AGREEMENT:** Successful tenderer shall enter into Agreement for carrying out AMC during guarantee period of one year and for a period of 3(three) years at the time of taking over the equipment by the Employer.
18. The successful tenderer shall carry out all the functions as per the provisions of the agreement & in accordance with the laws of the Government of Goa, wherever applicable as well as Major Ports Act, Dock Safety Rules and Regulation and all other applicable laws, rules and regulations from time to time and in accordance with prudent work practices.



**MORMUGAO PORT TRUST
ENGINEERING (CIVIL) DEPARTMENT**

TENDER No. CE/55/2016

**Name of Work: PROVIDING SIGNALLING AND TELECOMMUNICATION SYSTEM
FOR RAILWAY NETWORK AT MORMUGAO PORT, GOA.**

**(xiv) TERMS AND PAYMENTS FOR PART – I (i.e. SIGNALLING &
TELECOMMUNICATION SYSTEM_**

**1. Terms and Conditions of Payment for Part – I (i.e. Signalling &
Telecommunication System) Schedule – A Supply of Materials.**

1. 70% of quoted value of Item towards supply as per Schedule of Quantities Part-I - Signalling and Telecommunication System after receipt of all material duly certified by RDSO and approved by the consultant.
2. 20% of quoted value of Item for supply of Items on Installation of the Signalling and Telecommunication System.
3. 10% of value of order for supply of items after testing and commissioning of Signalling and Telecommunication System.

**2. Terms and Conditions of Payment for Part-I (i.e. Signalling &
Telecommunication System) for Schedule-B Execution, Installation, Testing
and Commissioning of Signalling and Telecommunication System.**

1. 90% of value of Item for Execution, Installation and Testing of Signalling and Telecommunication System (Execution of Work Schedule) on satisfactory Installation and Testing of Signalling and Telecommunication System.
2. Balance payment of 10% of value of order (Execution of Work Schedule) within one month of satisfactory commissioning of Signalling and Telecommunication System.

xv. CHECK LIST FOR SUBMISSION OF TENDER

S.No.	Particulars	Yes	No
1	Have you purchased / downloaded the tender document from internet for submission by your firm?		
2	Have you submitted cost of tender document in the form of DD or cash receipt, in case you have downloaded from internet?		
3	Have you submitted the tender in the Mormugao Port Trust's Form?		
4	Have you furnished full postal address, telephone number/Fax number, email?		
5	Have you kept your offer valid for 180 days as specified?		
6	Have you attended Pre-Bid meeting?		
7	Have you downloaded Pre-bid clarifications from Port web site?		
8	Have you submitted Demand Draft pertaining to Earnest Money? i. DD No. _____ dated drawn on bank _____ payable at _____ amounting to Rs.10,51,100/-		
9	Have you submitted documents pertaining to status/ contribution of the firm, partnership deed and power of attorney?		
10	Have you furnished Solvency Certificate from Nationalised or Scheduled Bank? Amount stated in Solvency Certificate Rs.3.50 Crores		
11	Have you submitted Audited Statement of Accounts for last three (3) years ending 31.03.2015?		
12	Have you submitted Copy of current Income Tax Return Acknowledgment?		
13	Have you submitted document in support of the Technical System Qualifying Criteria (Eligibility Criteria)?		
14	Have you submitted Memorandum of Understanding (MOU) with Original Equipment Manufacturer (OEM) of the EI equipment		
15	Have you submitted list of works in progress along with copy of work orders?		
16	Have you submitted Bar Chart/CPM chart?		
17	Have you submitted Performa 1 to 6?		
18	Have you submitted tender as Joint Venture with other Party?		
19	Have you submitted signed copy of Integrity Pact and enclosed in Technical Bid (Cover no.1)?		
20	Have you submitted failure data record as per Clause 9.2 of the Technical Specification?		
21	Have you submitted Permanent Account Number issued by Income Tax Department?		
22	Have you Signed and seal on every page of tender document submitted?		
23	Have you attested all the corrections?		
24	Have you signed and filled details in Vendor Registration Form		
25	Have you submitted Price Bid in separate Cover?		

NOTE:

The above Checklist is not exhaustive. The tenderer must go through carefully the entire Booklet and submit the tender compliance of all the conditions/ provisions instructions mentioned therein irrespective of the fact that they have been highlighted in the Check list or not.

Signature _____

Name of the Tenderer

Seal:

Date:

xvi) TECHNICAL SPECIFICATIONS

Interlocking is to be provided with Electronic Interlocking. Distributed EI architecture is to be adopted. Input/ Output gatherer is to be provided near the present panel room for the operation of signals - 1, 2, 5, 22, 24, 26, 28, 30, 32 & SPI 50. Points 101, 102, 104, 105, 106, 107 & 108. The Main EI and the I/O gatherers shall be networked with OFC cable with path protection.

MSDAC is to be provided for train detection. The MSDAC equipment pertaining to the sections controlled from I/O gatherer shall be co-located with I/O gatherer. The communication between two MSDAC systems located in main equipment room and I/O gatherer room shall be with OFC cable with path protection. The reset shall be carried out from the VDU of the EI. No physical reset equipment is required.

Technical Specification of MSDAC:

1. MSDAC shall be supplied from the approved vendor of RDSO as per the latest RDSO Specification 176/2013.
2. MSDAC equipment is to be provided in the Main EI room and EI (I/O) hut catering to the respective wheel sensors
3. The two MSDAC equipment shall exchange the information of bordering wheel sensors through OFC with path protection
4. Each wheel detection unit shall with one quad/ pair of 0.9 mm copper quad cable for its operation. Power for the wheel detection unit shall be carried by the same cable. No separate power cable is catered.
5. One PCB failure shall not cause all axle counter sections failure.

Distributed Electronic Interlocking:

1. Electronic Interlocking equipment shall be supplied from the approved vendor of RDSO as per the latest RDSO Specification.
2. EI equipment shall be distributed at main EI room and EI [I/O] hut
3. EI Equipment located in main EI room shall interface the signaling elements like points, signals, MSDAC, LC gates, Crank handle etc. in its Jurisdiction and also achieve the interlocking of the entire Yard.
4. EI Equipment located in EI (I/O) hut shall interface the signaling elements like points, signals, MSDAC, Crank handle, Slots etc. in its Jurisdiction. It works as I/O gathers only.
No interlocking is achieved in it.
5. The two EI Equipment shall exchange data through OFC with path protection.
6. All the point machine controlling, operating and detecting relays shall be located in their respective EI rooms. However, for point 137&138, controlling, operating and detecting relays are to be located at the respective point location.

Cable Termination:

1. Underground Signaling cables at CT Rack in the equipment room and in the location boxes in the outdoor are to be terminated in screw less terminals like WAGO or similar reputed Companies.
2. Quality of terminals required is not separately given in the schedule. Its cost shall be included in the cable laying and termination schedule. The type of terminals to be

used will be finalized in consultation with the engineer If the make is not clearly quoted by the tenderer.

Crank handle:

1. Crank handles shall be co-located with their respective EI rooms. However, point 137&138 Crank handles shall be located in a location box at the respective point locations.
2. Crank handle release shall be with a time delay for the Crank handle of 137& 138 points and the points controlled from EI(I/O) hut

17 Specifications to be followed by Contractor to Carryout the Work

17.1 GENERAL

Technical Specifications contained herein shall be read in conjunction with other Tender conditions as specified in other tender documents.

17.1.1 Various clauses have been drawn from the specifications from Indian Railways Standard (IRS) of Practice published by Bureau of Indian Standards (BIS) TEC etc. They have been modified, where necessary, to suit the present requirement:

17.2 The work shall be carried out as per approved Plans & Drawings.

18 It shall be according to the practices of South Western Railway

19 INTENT OF SPECIFICATIONS

19.1 Technical specifications, in accordance with which the entire work shall be constructed and completed by the contractor, are detailed herein.

19.2 Specifications are intended for general description of work, quality and workmanship. Specifications are not, however, intended to cover the minutest details and every aspect.

19.3 In the absence of any definite provisions on any particular issue in these Technical Specifications, reference may be made to the latest Codes, Manuals and relevant Specifications of TEC, BIS etc. For the items not covered by such codes and specifications reference may be made to the recommendations of relevant latest British (BS), German (DIN) or American Standards (ASTM, ASHO, AREA, ACI), in that order. Wherever these are silent, construction and completion of the works shall conform to sound engineering practice as approved by Engineer and in case of any dispute arising out of interpretation of above, the decision of Engineer shall be final and binding on the contractor.

20 EQUIVALENCY OF STANDARDS AND CODES

20.1 Wherever reference is made in the Contract to specific standards and codes to be met by the goods and materials to be furnished, and work performed or tested, the provisions of the latest current edition or revision of the relevant standards and codes in effect shall apply, unless otherwise expressly stated in the Contract. Where such standards and codes are national, or relate to a particular country or region, other authoritative standards which ensure an equal or higher quality than the standards

and codes specified will be accepted subject to the Engineer's prior review and written approval. Differences between the standards specified and the proposed alternative standards must be fully described in writing by the Contractor and submitted to the Engineer at least 28 days prior to the date when the Contractor desires the Engineer's approval. In the event the Engineer determines that such proposed deviations do not ensure equal or higher quality, or do not serve the requirements due to any reasons, whatsoever, the Contractor shall comply with the standards specified in the documents.

- 20.2 The materials which requires RDSO inspection shall be procured from RDSO approved vendors only as per RDSO specifications as mentioned in BOQ

21 **GENERAL REQUIREMENTS**

- 21.1 The design, documentation and execution of work shall be in conformity with the current practices of the SWR. The Contractor shall submit the documentations & drawings to Consultants for approval of the same and the work shall be taken up based on the these approved diagrams and plans only.

(i) The BOQ will be reviewed once again after approval of SIP.

(ii) The contractor has to execute all those items which are necessary for completion of the project irrespective of the provisions in the BOQ.

- 21.2 The materials other than RDSO inspections & Specifications shall be of good quality and shall be certified by the representative of the consignee.

22 **Supply of Standard Drawings / Specifications etc.**

All standard drawings, specifications, codes, manuals and other reference documents issued by Railways / RDSO / any Govt. or non govt. bodies required for the work shall be procured by the contractor at his own cost. The latest version of the same along with up to date correction slips if any shall be procured and one set of the same shall be supplied free of cost by the contractor to the Engineer and kept and maintained at Engineer's site office for ready reference. To this extent the General Conditions of Contract shall stand amended.

23 **Testing facilities**

- 23.1 Full testing facilities for testing of materials and works shall be provided by the contractor at its own cost. A fully equipped test laboratory with adequate equipment, personnel and facilities as required shall also be provided by the contractor at its own cost and at suitable locations at site of work.

- 23.2 Cost of all such testing of materials shall be borne by the contractor. To this extent the General Conditions of Contract shall stand amended.

24 **CABLE LAYING:**

24.1 **Cable plan:**

Cable plan with distribution chart for each cable shall be prepared for by the contractor leaving adequate spare conductors in each cable as laid down in para 15.3.2 of chapter XV of pt.II SEM (Signal Engineering Manual) i.e 20% of working conductors on each cable shall be left spare up to outer most points and 10%

beyond outer most points. The similar cable layout plans shall be prepared for telecommunication cables. The necessary approval shall be obtained from the site engineer before start of cable laying work. A distance of approximately 10 cm must be maintained between telecommunication cable and signalling cables. The signalling cables must be separated from power cables by a row of bricks between them.

24.2 **Cable Trench:**

Excavation of cable trench shall be made in all kinds of soils including clearing roots of trees, rocks etc., to a depth of 1.0M and to a width of not less than 0.35M providing proper protection as required while crossing power cables, pipe lines etc., The bottom of the Trench shall be levelled and got rid of any sharp materials. Trenches shall be straight as far as possible and steep angles shall be avoided. MPT consultant will indicate alignment of the main cable route as well as track/road crossings.

- a) Signalling/ Power cables shall be laid as close to the track as possible. The cable track separation distance both within station limits and in the block section should not exceed 6 Meters.
- b) It is desirable that the excavation of trenches is not done in long lengths and does not remain uncovered overnight. It is preferable that trenches are dug, cable laid and refilling done on the same day.
- c) Wherever if rock formation is experienced and trenching cannot be done to a depth of 1 Meter, the trench shall be dug as far as possible and protective measures taken to avoid damages of cable as decided by the Site Engineer. Payment of trenching shall be made proportionate to the depth of trench and no payment shall be made for any extra excavation carried out in the slope and width of the trench. The contractor, who supervises the excavation shall take the shoring materials ready on hand, so that on banks where ashes or loose materials are encountered, shoring can be adopted. However the minimum depth shall not be less than 300mm for laying RCC pipes in hard murrum. Whenever rocky soil is experienced, concreting has to be done for a depth of 150mm after laying the cable to protect them.
- d) During excavation of the trenches, the earth should not be thrown on the ballast. The earth may be thrown on the side of the trenches, away from the track. Complete excavated earth shall be back filled in the trench after laying the cable and well rammed.
- e) Whenever power cables are to be laid along with other cables bricks are to be laid lengthwise approximately five bricks per meter for separating power cables from other signalling cables.
 - Spreading of loose soil in the excavated cable trench to a depth of 75mm and after laying of underground signalling cables/power cable as per the cable plan covering the cable, with loose soil to a depth of 75mm
 - Minimum distance between the signaling cables and OHE masts or other structures likely to develop high potential or switching stations earth.

DEPTH OF CABLE (Metrs)	DISTANCE (Meters)	REMARKS
Upto 0.5	1.0	
	0.5	Provided cable is laid in concrete pipes/ heavy duty HDPE pipes / Ducts or any other approved means for 3M on either side of the mast.
More than 0.5	3	

Minimum distances between signaling cables & OHE mast or switching station earth.

Description	Distance (M)	Remarks
Equipment of sub-station, OHE mast or sub-station earth	1.0	Cable shall be laid in concrete pipes/ heavy duty HDPE pipes/ split RCC pipes or any other approved means for 300M on either side of the feeding point.
Any metallic body of Switching station	1.0	
Switching station earth	5.0	
	1.0	Provided cable is laid in concrete pipes/ heavyduty HDPE pipes/ Ducts or any other approved means

- Before the cables are laid, a visual inspection of cable shall be made and it shall be tested for insulation and continuity of cores. The insulation resistance of new cable shall not be below 500 M. ohms per KM at 20 degrees centigrade.
- If there is wide disparity between insulation of different conductors, the conditions of the cable should be thoroughly checked before permitting its use. Bedding and armouring shall be inspected to see that there has been no damage during transit or in storage. In case where the wheels are not available or the area is not convenient for rolling the wheels along with route, the drum shall be mounted on the axle at one end of trench with adequate number of men ensuring that the insulation of the cable is not damaged and no kink/twist is formed. In no case shall the drum be rolled on the road for laying of cables and the cable dragged on the ground for laying purposes. The cables shall be laid gently into the trench and not thrown out under any circumstances. Before laying of cable in the trench, a visual inspection shall be adequate for any damage or defect throughout its length.
- Normally, cable laying should be commenced only after the relay room and cable termination box on the route at the respective stations are ready, and the cable should be fully terminated at the relay room/apparatus cases, immediately after the cables are laid. However, if for any reasons the cables

are to be laid in advance, special care should be taken to ensure that the coiled cable near the relay room/apparatus case is fully protected before and during final termination. The coiled cable should be fully covered with a layer of bricks in its entire length and provided with adequate number of cable markers. On no occasion the ends of the cable should be left unprotected. The cable ends shall be sealed with cable compound.

- Cable laying shall commence only after the depth and width of the trench, quality of bricks and sand are jointly inspected by the Mormugao Port Trust/Consultant Engineers representative and Contractor's representative and approved.
- Cables shall not be normally taken over the running tracks at the time of cable laying by the contractor as this is likely to cause accident to trains and damage to cables. If at any time the cable has to be taken across the track either in full drums or in spread out conditions, it shall be done only in the presence of Mormugao Port Trust/Consultant Supervisory staff and also after safety precautions have been taken to post flagmen on all the sides as may be required to stop any train approaching the site of the fouled line.
- At each end of the main cable/tail cable/power cables an extra coil length of 6 to 8 meters should be kept.
- At the time of commissioning of the cables, the insulation values of the cable should again be checked and the value obtained shall not be below 500 M. Ohms per KM at 20 degrees C. If there is wide disparity between insulation of different conductors, the conditions of the cable should be thoroughly checked before permitting its use. The readings shall be recorded in the register for all cables.
- The contractor shall furnish the final as made cable plan and cable route plan showing the distance of cables from the nearest track center at every 30M interval and location of apparatus cases.
- After the signalling cable/power cables are covered with loose soil as in Para 6.3 one layer of country bricks of size 220mm X 100mm X 60mm approximately, shall be placed closely in breadth wise.
- After the bricks are placed over the cable without any gap between two bricks properly, the excavated earth shall be again put up in the trench. It shall be ensured that there are no stones or any sharp materials present. The refilled earth shall be consolidated and extra earth also shall be placed on the trench to compensate the sink-age and consolidation of earth.
- Cable markers have to be fixed at interval of 30M throughout the cable route, diversions and also on either side of track crossing along with the cable route.
- Contractor shall be fully responsible for making necessary preventive arrangements to avoid theft/damage to cables, during construction period and

upto handing over of station after commissioning. In the station yard, all cables should be protected by laying in buried RCC duct/DWC HDPE pipe.

- Wherever the cable coil pits are required to be provided, the cable coil pit shall be excavated to a size of 1.0mx1.0m and a depth of 1.0m in rear of location boxes and to a size 2.0m x 2.0M and a depth of 1.5M in rear of Relay room and cable huts. After all the cables are drawn and coiled, over the coiled cable one layer of country bricks of size 220mm x 100mm x 60mm shall be placed throughout entire area of the bottom of the pit without any gap and then refilled with earth and consolidated.

25 **TRACK/ROAD CROSSINGS:**

Whenever signalling/power cable has to cross the track/road, it shall be ensured that:

- i. The cable crosses the track/road at right angles.
- ii. The cable normally does not cross in between or inside points and crossings.
- iii. The track/road crossings to be carried out as per the instructions of Engineer at site.
- iv. The work includes removal of ballast, cutting of trench across track/road at the places indicated by the Engineer, and covering the trenches after placing RCC pipe/DWC HDPE pipe in position.
- v. RCC pipe 150mm inner dia/ DWC HDPE pipe 175mm inner dia shall be provided for track/road crossings. For each track crossings, two numbers of RCC pipes/DWC HDPE pipe each 2M long with collar shall be provided. For each road crossing, required number of RCC pipes each 2M long with collar shall be provided depending upon the width of the road.

26 **FOUNDATIONS:**

- 26.1 The top level of the foundation shall be in level with the existing rail level as far as possible. The proportion of cement, sand, ballast shall be in the ratio of 1:3:6 for casting foundations for signals, location boxes and the proportion will be cured for a period not less than 7 days.
- 26.2 Fine aggregate must consist of sand, stone ballast not exceeding 40mm X 40mm size and cement. The sand and ballast must be clean and free from soil, clay, shells, soft or flaky materials or any vegetable. Ballast must be washed when necessary to ensure cleanliness.
- 26.3 Sand used must be tidal river sand and must be free from any salts.
- 26.4 Water used for mixing must be clean and free from any oil, alkali and acid.
- 26.5 Materials for concrete must be carefully and accurately measured for every batch.
- 26.6 Mixing must be done in a mixing trough or a M.S. sheet, which should not be, more than half full at the time of mixing. Two men shall use square ended shovels and not powrahs. Water must be added by pouring continuously until all materials and water are thoroughly mixed and uniformly combined.
- 26.7 When batch is fully mixed, it must be used without any delay. The aggregate shall be deposited in uniform layer not exceeding 15 Cms. Tamping and spreading of each layer shall be done so as to cause it to settle thoroughly in the form and produce a dense mass.

- 26.8 Forms must be drenched with water before the concrete is placed against them and must not be removed in less than 36 hours afterwards.
- 26.9 A template for each foundation should be prepared suiting the holes in the base of the location box or signal post (for which foundation is cast) in order to hold the anchor bolts in position till the foundation is cured. The template shall be removed before the top of the foundation is given fine finishing.
- 26.10 The exterior surface of the foundation should be finely finished leaving 4 Cms. of thread portion of the anchor bolt free to enable erection of signal post or location boxes. All foundations shall be cast under the direct supervision of the Engineer of the work. Curing must be done for all foundation for not less than 7 days.
- 26.11 No payment shall be made for any extra excavation carried out in the slope and width of the pit, including for foundations where soil is loose and pit is to be dug for more depth.

27 APPARATUS CASES/ LOCATION BOXES:

- 27.1 The work consists of pit excavation, casting foundations with bolts of adequate size having cement concrete of ratio of 1:3:6 with stone ballast of 40mm size as per: The position of Location Boxes will be finalized by the Engineer. It shall be fixed taking care that staff working on location boxes do not endanger from running train.
- 27.2 All Location Boxes/ Battery Boxes shall be erected on concrete foundation and plumbed. It should be clear of infringement when the doors kept open perpendicular to the track. All foundations shall be plastered on all sides and earthwork shall be made up to the required level. All the Location Boxes used shall be painted on inner side with white paint before fixing the shelf planks and terminal board after a primary coating with red oxide and with Aluminium paint on outer side after installation at site.
- 27.3 Teak Wood planks of 20 to 25mm thick to be sized and planed for fixing ARA terminal/fuse block. Wood screws of proper size shall be used. The size of terminal boards and shelf planks shall be finalized by Mormugao Port Trust/Consultants site Engineer. Two holes on either side of terminal/fuse block shall be made if required for carrying out wiring termination. Shelf plank be securely fixed in level on suitable M.S. angle brackets. Wood polish/ varnish of good quality shall be applied before fixing terminal/gadgets.
- 27.4 The underground signalling cable shall be taken into the apparatus case/battery boxes and properly secured by wooden clamps/cable gland plates.
- 27.5 The cables shall be neatly skinned, bunched and terminated. All cores of cable shall be terminated on the terminal board at locations and in Relay rack at the required places in the order as approved by Engineer. All the power cables (Aluminium) shall be provided with Aluminium lugs using crimping tool.
- 27.6 All Location Boxes shall be provided with 'E' type lock arrangements on both the doors as per instructions at site. Contractor shall procure material and fabricate for fixing of 'E' type lock if such provision did not exist on the Location box.
- 27.7 After all the signalling cables are taken inside the Location box the side opening shall be closed with masonry work and plastered. The inner side is then filled with sand and finally the bottom is sealed with sealing compound.
- 27.8 Location Box and the armours of all the cables shall be earthed properly as per standards. Excavation of a pit at a given location shall be done as per Drg. No. S&T/SG-037/2005 on natural soil, fixing earth pipe covering the same with a mixture of 2 Kg. of charcoal, 2 Kg. of common salt and earth. This includes brick masonry around the earth. GI pipe of size 50mm X 3M with 12mm dia holes on the sides at intervals of 300mm shall be used as earth electrode as per Drg. No. S&T/SG-

- 035/2005. If more than one Location Boxes are grouped at a place, common earth can be provided for cluster of location boxes at one place.
- 27.9 The earth resistance shall not be more than 10 ohms. Earth resistance and its date of measurement are to be painted on earth pit.
- 27.10 Track relays, line relays, overload relays, transformers, track feed chargers, rectifiers, charged secondary cells, track feed resistance, EKT, telephone plugs etc., shall be fixed neatly in the Location Box as suggested by Engineer. The wiring shall be carried out in a neat manner with 3/0.75mm PVC copper wires and terminated, bunched and tested. The relays wherever fixed shall be fixed in such a manner that they cannot be easily removed or tilted. Details of cable terminations and wiring particulars shall be painted inside the Location Boxes on their doors in addition to documentation. Contractor shall procure and fabricate M.S flats/angle for relay fixing, inside Location Box. Relay fixing arrangements shall be firm and rigid to avoid any chance of vibration due to train movements.
- 27.11 All electrical equipments wherever provided shall be earthed. Description of equipments, relay etc., shall be neatly painted inside the Location Boxes on their doors. All the internal wiring shall be tested from point to point jointly by contractors authorised Engineer and Consultants.
- 27.12 Charged secondary cells if installed inside the Location Boxes, shall be fixed firmly leaving working space for taking specific gravity reading and distilled water topping. Additional ventilation arrangements shall be made. The date of installation, capacity and serial number shall be painted on each cell and the inner side of the door. The record shall be maintained in a proper format for each battery set as per Consultants. laid down practice.
- 27.13 Battery links (lead) with suitable bolts and nuts shall be used for connecting cells. Petroleum jelly is to be applied on terminals immediately after connection. The specific gravity and voltage reading shall be recorded in a separate register and handed over to Engineer duly signed as explained in para above.
- 28 **POSITION LIGHT SHUNT SIGNAL GROUND TYPE:**
- 28.1 The work includes excavation of pits, casting of shunt signal foundations as per Drg. No. S&T/SG-002 /2005, using Anchor bolts of size 20mm x 450mm.
- 28.2 Foundations for shunt signal should be of cement concrete with ratio of 1:3:6 using stone ballast of 20/25mm size to be cast at location shown by the Mormugao Port Trust/Consultant's representative. The foundation is to be plastered in all sides with 1:3 cement, sand mix.
- 28.3 The position light shunt signal shall be properly mounted on post and plumbed.
- 28.4 Necessary earthwork shall be made for each position light shunt signal if required by Consultants. The cables are to be taken through the post to the unit, skinned and terminated.
- 28.5 Position light shunt signal are to be wired by using 3/0.75 mm copper wire as per approved practice of the Railway. The wiring is to be tested jointly. The shunt signal to be focused correctly in day time at bright light at rated voltage. The signal units back door covers are to be locked using universal locks. Soon after installation, the pole shall be painted with a aluminium paint after giving a coat of primer and the Signal unit shall be painted with black enamel paint.
- 28.6 The position light Shunt Signals are earthed as per practice of Zonal railway.

29 **POINT MACHINES:**

- 29.1 IRS type shall be fitted in level to all points as per signalling plan For curved switches of 1:12 and 1:8½ with 143mm throw electric point machine with RDSO drawing S-10910 shall be used.
- 29.2 The point machine shall be installed after cleaning both inside and outside the machine, after greasing/oiling to all moving parts. The point machine shall be hand operated and detection and motor-controlling contacts shall be adjusted before taking to site. All unwanted openings shall be covered with MS sheets.
- 29.3 The point machines shall be fixed with proper bolts, nuts and flat/spring washers with correct size of holes through the special sleepers to avoid lateral/longitudinal play, on extended Gauge Tie Plate.
- 29.4 All point connecting rods shall be connected to point machines without any strain and with Min. offset. All connecting rods shall be in level and correct size of bolts and nuts shall be used to avoid longitudinal play. Any changes in the connecting roddings during installation which necessitates welding and offsets shall be carried out by the Contractor at site. The welding shall be by smithy process. The point roddings shall be suitably provided with insulation joints as per track circuit requirements.
- 29.5 Separate junction box shall be installed clear of infringement near the point machine and the respective cables shall be terminated. The leading in wires from the boxes shall be taken through flexible conduit PVC pipes and securely fixed. The wiring inside the point machine for motor and detector circuit shall be carried out neatly. All the electrical wiring shall be tested for insulation and earth and all connections tightened. PVC copper wire/cable of sufficient capacity shall be used for wiring point machines as per standard practice.
- 29.6 Point machines and junction boxes shall be painted and point numbers shall be written neatly with paint. Wiring diagram shall be painted on the inside of the point machine cover. The point switches web shall also be written with point number.
- 29.7 The point machines shall be wired in such a manner so that independent operation and detection feature is obtained in point control and detection circuit. No superimposed detection shall be used. The point group relay shall be of modified design in light of railway Board letter no 2004/signal/Awr/1 dated 29.1.2005.
- 29.8 **Adjustment and Testing:**
- The point machine shall be worked by crank handle and the housing of switch rail with the stock rail shall be checked.
- 29.8.1 The point machine shall be worked both ways with proper feed without undue friction and working current shall be recorded.
- 29.8.2 The point detector and lock connections are adjusted in such a way that with a 3.25 mm thick test piece obstruction placed between the switch and stock rail at 150mm from the toe of switch - The point does not get locked and the point detection circuit is not completed.
- 29.8.3 The point machine cover shall be locked using universal locks or approved means as per practice of the Railway.
- 29.8.4 The point machine de-clutch arrangement should be properly adjusted so that it works satisfactorily under condition of obstruction. The feed to motor shall also be disconnected after a period of 9 to 11 seconds.

30 **TRACK CIRCUITS:**

- 30.1 The connections to rail by channel pins, the work includes bonding of rail joints which shall be made with rope wire, holes are to be drilled close to fish plates on the web of rail and the bond wires are fixed by driving channel bond pin, tightly. In point track circuit parallel jumpers of bond wires/cables shall be provided as required.
- 30.2 Track Lead Junction Boxes (TLJB) shall be fixed clear of infringement and the respective track circuit tail cable 2 X 2.5 Sq.mm PVC copper conductor from the apparatus case shall be terminated. The connection from the TLJ boxes to the rail should be through the solid GI soft wire 8 SWG/wire rope which should be fixed to the Rail by channel Bond pin both at feed and relay ends. The GI wire from TLJ boxes to sleepers should be covered with suitable PVC covered sleeve and there upon neatly clipped on the sleepers to prevent shorting with nails. Insulations/ gromates - PVC shall be provided on TLJ box to prevent GI wire earthing. Double lead wire shall be provided both for feed and relay ends.
- 30.3 The TLJ boxes shall be painted and track circuits shall be neatly numbered as per approved signalling plan.
- 30.4 Polarity bonding in point track circuit in duplicate shall be provided for each point track using 8 SWG GI soft wire/wire rope insulated and clipped to sleeper. Parallel bonding shall be done wherever required.
- 30.5 Track circuit work includes fixing of track feed and track relay equipments in the apparatus case as indicated by the Engineer. Track relay details shall be painted on the inner side of the apparatus case door. Suitable flexible copper wire shall be used for wiring the track relay; track feed equipment, batteries, chokes, etc. and finally terminated at the terminal block. For each track circuit, secondary cell 80 AH shall be charged and installed in the apparatus case. The No. of cells and chokes to be used for each track circuit will be as per the following table:-

Length of Track Circuit	No. of Cells (2.2v)
Up to 450M	TWO
450M to 700M	THREE
Above 700M	FOUR

- 30.6 The secondary cells shall be charged by the contractor through reputed agencies.
- 30.7 Any alteration to existing track circuits shall be done by the contractor at his own cost.
- 30.8 After completing the installation of track circuit, it shall be energized, tested, adjusted and readings recorded in a register/track circuit history cards.
- 30.9 Supply of technical documentation and drawing shall be done by contractor. Supply of all miscellaneous stores required for completion of work except the one explicitly mentioned in the scope of work of Mormugao Port Trust shall be done by the contractor.

31 **LIFTING BARRIER GATES:**

- 31.1 The work consists of casting foundations with cement concrete in the proportion of 1:3:6 with approximately 40mm graded stone and river sand, plastering the exposed portion including the portion on the sides upto a depth of 150mm below the ground level for:-
- 31.2 Two Nos. of lifting barrier pedestal using 6 Nos. of anchor bolts of size 25mm x 900mm for each pedestal.

- 31.3 Two Nos. of lifting barrier stands using 4 Nos. of 20mm X 450mm anchor bolts and nuts for each stand.
- 31.4 Lifting barrier winch mechanism using 4 Nos. of 20mm X 450mm anchor bolts and nuts.
- 31.5 Breaking of metal/tar road and excavating duct of 300mm wide and 300mm deep, laying of channel for passing of wire/rod, fabricated with coupled beam 150x75mm fitted one above the other with bolts & nuts so that two sets of such coupled beam form a channel running across the road. The channel is required to be covered by MS plate 20 mm thick suitably fixed over MS beam throughout with bolts and nuts at minimum spacing of 1m. Necessary masonry work and fixing of channel and MS plate with bolts and nuts shall be done by contractor. The duct shall be closed, rammed and leveled by the contractor.
- 31.6 Painting the lifting barrier with two coats of enamel paint of approved quality as given below:-
- a) Stands upright and other: Black
 - b) Boom: Black and yellow stripes 300mm wide alternatively.
 - c) Stop disc on the boom: Red
 - d) Rodding complete with trestles with Red oxide paint.
- 31.7 The communication between Level crossing gate and ASM of nearest station shall be with magneto phone. However where ASM has to communicate to more than two LC gates selective calling equipments shall be installed.

32 **CABLE TERMINATION RACK:**

- 32.1 Cable termination racks shall be erected in the relay room at the required location as shown by the Railway with suitable foundation bolts and cement concreted. The cable termination racks shall be painted soon after installation before cable termination work is taken up. Suitable cable ducts wherever required shall be provided to bring all outside cables to the termination rack. All the cables are to be neatly skinned, fixed on the cable bracket and terminate in order. The cable armours and the rack should be earthed. Internal wiring and termination particulars are to be written with paint.
- 32.2 The terminal blocks are to be fixed on suitable MS flats, which are fitted to the cable termination racks and held rigidly by machined screws,. The 6 way terminals are to be numbered serially with paint on the C.T. rack and details of termination are painted on Decolam/Hylam sheet and fixed in the relay room.
- 32.3 All the cables shall be identified by punched labels tied on each cable. Painted cable termination index board shall be fixed in the relay room showing the terminal numbers of the circuit. As made terminal particulars shall be prepared in linen/polyester tracing signed and handed over to the Mormugao Port Trust/Consultant.

33 **RELAY RACK:**

- 33.1 Relay rack frame to accommodate 2/3 way, relay rack is to be fabricated out of 2 Nos. vertical supporting angle of 65mm x 65mm x 2075mm and bottom and top frame angle of 65mm x 65mm x 1100mm (for 2 way) or 1650mm (for 3 way). Relay rack is to be fabricated out of 40mm x 32mm x 2048mm angles in vertical position spaced 530mm apart by the flats one at the top and the other at the bottom welded to

- the angle. The relay racks are fitted to the frame angle by 20 x 75mm bolts with washers and spring washers.
- 33.2 The frame is held rigidly by the base assembly and electrically isolated by insulator. Angle plates 65 x 130 x 6mm are welded to the vertical frame angle at the top to facilitate fixing of 'L' bracket, electrically isolated by insulator. Ladder is fixed to the ladder supporting angle by 12 x 20mm bolts and nuts with washers and spring washer. The base assembly is anchored to the ground by means of 'J' type foundation bolts 12 x 100mm with washer and spring washer. The exact requirements of wall angles and cable ladder are to be arrived at taking the disposition of the relay racks in the relay room. The cable ladder brackets are to be provided with plastic sleeves to avoid injury to the wires and multi core cables run on the ladder. Alternative ladder arrangement for carrying the wires as per the instructions or approval of Engineer of the work can be fixed.
- 33.3 Relay racks erected in the relay room shall accommodate 'Q' style in different racks. Not more than 48 Nos. of 'Q' style relays (8 rows of six relays) / are to be mounted on a rack and while working out the relay requirements, it must be ensured that at least one front and one back contact is left as spare
- 33.4 The disposition of relays in the relay rack shall have to be carried out as per the directions of the Site Engineer.

Important points to be kept in mind while numbering the circuit diagram

Maintaining uniformity:

Maintain same contact for stick path in stick circuit. (A1/A2 in case of QNI relays),

33.4.1 INTER CHANGEABILITY OF RELAYS:

As far as possible, the contacts shall be so allotted that definite contacts are allotted first and then the deciding contacts so that relays of any contact configuration may be installed.

- 33.5 Frames for fixing 6 Nos. of 'Q' style relays in a row with mounting arrangements are to be fixed to the relay rack by suitable screws/bolts and nuts. The interconnection between the Panel and relay rack as well as between the 'Q' style relay racks, are to be carried out as per instructions at site. Suitable mounting arrangements and fixtures are to be supplied by Contractor.
- 33.6 Relay plug boards of 'Q' series relays are to be fixed to the relay rack on frames made out of MS flat of suitable size. Not more than 48 relays are to be mounted on a rack and at least one front and one back contact must be left as spare in a relay.
- 33.7 Suitable mounting arrangements for fixing non-deteriorating fuses, condensers and resistors to suit the circuit requirements are to be fabricated on Bakelite Hylam sheet together with necessary screws bolts and nuts by the contractor. All racks are required to be earthed with cable earth available in relay room.

34 WIRING:

- 34.1 The equipments are to be wired in relay room, Station Master's office power supply arrangements, apparatus case/location box. CT box, battery box and in other locations as per circuit diagram.
- 34.2 Contact numbering for the relays shall be made as per the approved circuit diagram and type of relay proposed to be used on the installation.
- 34.3 Wiring of and plug in type (Metal to Carbon) contact relays shall be done as under:

- 34.4 32.3.1 Relay rack wiring housing plug in type relays conforming to BRS-930 and BRS-931 and shall be done with "PVC insulated unsheathed flame retarding type single core flexible wire 1100V grade having 16/0.2mm annealed copper conductor and nominal cross sectional area of 0.5 Sq.mm of common colour code to the specification IS: 694 Pt.I or wiring these relays the above wired shall be terminated on eyelets/lugs of standard design.
- 34.5 The wiring between the terminal board of the panel and the unwired tag block on the relay rack is to be carried out using multi-core cables (40 core or 60 core) 0.6mm/1.0 mm dia annealed tinned copper wire to IS : 694. The wiring on the 'Q' series relay rack is to be carried out by 16/0.2 mm dia single core multistrand flexible A.T. copper wire to I.S. 694.
- 34.6 Soldering at the tag block terminals shall be made using good quality Solder and Flux. Care must be taken to prevent dropping of excessive solder from terminal thereby causing failure/unwanted connection or short by fusing of PVC insulation in the row below it. It is advisable to raise the wires by mechanical means and temporarily interposing a wooden or plastic sheet between the adjacent rows while soldering, to collect the excessive solder that may be dropping out.
- 34.7 After testing, the loose wires on the cable ladder shall be neatly bunched and laced with twine black. A suitable colour code for wiring shall be adopted as required .
- 34.8 Various supplies associated with signalling viz., 110V AC, 110V DC, 60V DC, 24V DC, 12/24V AC and 12/24V DC flashing are to be brought out to the equipment rooms.
- 34.9 The incoming cables to the relay room are to be neatly arranged and fixed to the cable supporting and guiding rack. The duct shall be filled with sand and plastered neatly to avoid entry of mice or reptiles.
- 34.10 The nomenclature of each relay shall be painted both in front and rear side of each relay with contact configuration. The relay index sheet duly painted of details of relay and their position in the relay rack shall be manufactured out of Decolum/ Novapan sheet and fixed in the relay room. All the relays to be plugged shall be checked visually and defect if any, noticed shall be replaced duly reporting the same to the Mormugao Port Trust/Consultants. As made relay rack wiring and contact chart of all relays shall be prepared in linen/polyester sheets, duly signed and handed over to Mormugao Port Trust/Consultants.
- 34.11 Suitable arrangements shall be made in the relay rack for fixing condenser and resistance unit, required for slow to release feature. Letter painting shall be made against each unit to identify circuit to which it is used.
- 34.12 All circuits shall be carefully protected by individual fuses in the relay room and locations grouped preferably to facilitate easy fault location. Fuses shall be so arranged that they can easily be placed without causing interference to other circuits. Charts showing the arrangements of fuses and the circuits in which they are used shall be prepared and kept in the relay room. Fuses for all Signalling circuits shall be of the non-deteriorating type as per RDSO specification.
- 34.13 Fixing of EKT/HKT with Micro Switches 2 NO/2NC at gate lodge, S.M's office on Teak wood board, providing telephone at site/gate lodge/SM's office, carrying out wiring of EKT/HKT, telephone using 16/0.2mm wire and testing as per approved circuit diagram and commissioning the same. Wiring has to be neatly clipped wherever necessary.
- 34.14 The inter-connections arrangements includes laying of multi core hook up wire cables, inter connection between Generator room, battery room, power rack and

cable termination rack by using sufficiently thick wires not less than 7/1.4mm PVC copper or 10 Sq. mm. multi strand copper conductor to avoid the voltage drop.

- 34.15 The ladder arrangements provided shall be of suitable capacity fixed neatly and firmly with proper supports. Cable details, functions allotted to each core and terminal numbers shall be prepared and handed over to Mormugao Port Trust/Consultant.
- 34.16 All connections/terminations shall be tested by the contractor and after satisfying himself and then to be tested jointly with Mormugao Port Trust/Consultant representatives. Any alterations shall be carried out by the contractor before commissioning of installation at free of cost.
- 34.17 Any addition/alterations in the wiring of relay racks control panel and cable termination racks, power rack, battery room and in apparatus cases involving safety shall be carried out by the contractor at free of cost during testing/commissioning and for a period of 3 months after commissioning of the installation.

35 INSTALLATION OF DATA LOGGER:

The installation and commissioning of data Logger includes wiring between Data Logger equipment and relay rack/power equipment room. The potential free contacts of relays to be monitored will be made available on the tag block of the data logger.

36 DEI SYSTEM:

- 36.1 A performance statement giving a list of major supplies effected in last 3 (Three) years of the DEI equipment offered giving details of the purchaser's name and address, fax, phone and e-mail, order number and date and the quantity supplied in assurance of performance guarantee.
- 36.2 A statement indicating details of equipments employed and quality control measures adopted by the manufacturer.
- 36.3 The contractor shall procure sufficient number of spare cards/modules/components for in view of free maintenance of the DEI System during warranty period of one year. The tenderer/manufacturer shall undertake to enter into AMC (Annual Maintenance Contract) with Mormugao Port Trust beyond warranty period under which supply of spares, repairs to defective cards and call charges for each visit as may become necessary shall be covered. The warranty period for DEI System shall be 365 days from the date of commissioning.

37 TRAINING FOR SPECIALIZED EQUIPMENT

- 37.1 The tenderer shall undertake to train Mormugao Port Trust personnel nominated by Mormugao Port Trust in different aspects of equipment design, functioning, field installation, testing, commissioning, operation, maintenance and repair, covering both hardware and software. The training should be comprehensive so as to impart full knowledge to Mormugao Port Trust personal deputed for the training to independently execute the installation, operation, maintenance and repair of all equipments. The training course should, apart from formal classroom training, include hands on practical experience and visits to working installation. The contractor shall make all necessary arrangement for the same. The place of training shall normally be at the manufacturer's premises or as decided mutually between the Mormugao Port Trust/Consultant and the contractor.
- 37.2 The contractor shall at every stage of testing and commissioning provide all facilities for adequate training of Mormugao Port Trust personnel who may be deputed to work on the project.

37.3 The cost of all travel to and fro the place of training, boarding and lodging of the trainees shall be borne by the Contractor.

37.4 The tenderer shall undertake to train Mormugao Port Trust personal nominated by Mormugao Port Trust in different aspects of equipment design, functioning, field installation

38 POWER SUPPLY ARRANGEMENTS:

38.1 The IPS shall use 300 AH low maintenance batteries for the signalling system at a wayside station and 120 AH for LC Gates. The IPS shall be based on SMPS design as per RDSO specification no.RDSO/SPN/165/2000 with latest amendments.

38.2 The IC of IPS shall be handed over to MPT and one copy to consultants before commissioning.

38.3 As made power supply diagram shall be submitted duly indicating the power supply details and position of the equipments including fuse ratings.

38.4 Maintenance free earth shall be used for IPS earthing.

38.5 The power room shall be provided with single door lock arrangement.

39 LEAD ACID / LOW MAINTENANCE BATTERIES:

39.1 The charged Batteries shall be provided in the Battery room and apparatus cases as per instructions of site Engineer.

39.2 Charged Batteries of different capacities shall be installed in the battery room and apparatus cases on suitable battery racks. The battery stand shall be given anti-corrosive black paint before installation of battery. The cells shall be arranged neatly with sufficient working space for maintenance.

39.3 Battery Stands:

The batteries shall be placed with space for easy maintenance on the steps arranged in the Battery Room and connected in series rigidly. The battery room shall have the Acid Proof tiles with exhaust fans.

39.4 Cells are to be connected with suitable links sufficient to carry full load. Immediately, after connection, petroleum jelly shall be applied on battery terminals. The wiring shall be carried out by PVC 7/1.4mm copper wire /10 Sq.mm multi strand copper wire and terminated in the terminal board in the battery room. The details of batteries and the capacity, circuit, date of installation etc., should be painted. The specific gravity and voltage reading shall be recorded for each cell in a separate register, along with the guarantee certificate of the supplier and handed over to Mormugao Port Trust duly signed. A wooden stand for keeping Hydrometer shall be fixed in each battery room.

39.5 All connections terminations shall be tested by the contractor to his own satisfaction and then to be tested jointly with Mormugao Port Trust's representative. Any alternations shall be carried out by the contractor before commissioning of installation.

39.6 Procedure for Initial Charging of Secondary Cells:

39.6.1 All the cells in the battery set shall be of the same type and capacity.

39.6.2 Electrolyte shall be prepared by mixing battery grade Sulphuric Acid and distilled water in the ratio 1:5 in a glass/Porcelain container by adding Acid to water and not vice-versa.

- 39.6.3 The new cells shall be cleaned with distilled water and filled with this electrolyte up to 12-15mm above the plates.
- 39.6.4 Allow the plates of cells to soak in the electrolyte for 12 hours.
- 39.6.5 Charge shall be applied at the rate of 4% of AH value of the cells to the correct terminals of the battery set duly interconnected.
- 39.6.6 Specific Gravity and voltage of each cell shall be measured and recorded once in 8 hours.
- 39.6.7 Charging shall be stopped when specific gravity becomes 1210.
- 39.6.8 If the specific gravity does not attain this value, little quantity of electrolyte shall be taken out and with electrolyte of higher value (1400 obtained by adding acid and added water in the ratio 7:11) and charging shall be started afresh.
- 39.6.9 On charge, the cells shall be discharged with lamp load up to the limit when the specific gravity becomes 1190 and voltage 1.85 volts.

Charge and discharge cycle shall be repeated once again.

Final charge shall be putting the cells to use.

40 INSTALLATION OF STAND-BY DIESEL GENERATOR SET:

- 40.1 The stand by diesel generator set with control panel shall be installed in the generator room as per standard practice using anti-vibration packing to minimize the vibration. The exhaust pipe to be extended outside the room with minimum number of bends and the silencer is fixed towards the off side of the operating panel Room. Required number of anti-vibration mounting (cushy foot) shall be provided by the contractor.
- 40.2 Necessary asbestos rope should be wrapped around the exhaust pipe. The control panel of the Diesel Generating set should be properly mounted. The wiring of generator and the control panel shall be carried out using PVC 7/1.40mm copper wire through PVC Pipes, PVC bends and terminated. An hour meter shall be provided as directed by the Engineer. The changeover switch and phase selector switch shall be provided and connected for changing over, from normal power to stand by and vice-versa or from one phase to another on suitable fixtures as instructed by the Engineer at site.
- 40.3 The stand by generating plant and control panel shall be earthed.
- 40.4 Secondary cell of required capacity shall be installed and connected for self-starting facility.
- 40.5 The push button start arrangement shall be given. The push button start arrangement of the generator shall be fixed in panel room at suitable location. The wiring shall be done by nearest possible route with appropriate size of wire so that remote start and stop of generator works satisfactorily.

41 CRANK HANDLE INTERLOCKING:

- 41.1 Electric key transmitter with crank handle fixed to the key shall be installed on Acrylic sheet/Glass fronted Teak Wood box firmly on suitable angle supports, in SM's room & apparatus cases as indicated by site Engineer. The wiring of EKT fixed with crank handle shall not be exposed. It has to be ensured that proper supports, have been given to the crank handle to avoid undue strain to the mechanism of the EKT. A push button with 2 NO/2 NC contacts of reputed make viz., L&T/Crompton make and 3 Nos. of LEDs Red, yellow and green shall be provided inside the box to give crank handle "Out", crank handle "IN", crank handle "FREE" indications. Nickel coated

- welded chain handle and key, locking and sealing arrangements. 37mm brass locks good quality should be provided.
- 41.2 Wiring shall be done as per approved circuit diagram (This includes necessary mounting of the box to the wall using TW plugs and cement mortar. All materials to be arranged by contractor)
- 42 **WARNING/STOP BOARD:**
- 42.1 Warning/stop boards fitted on the Rails/angle/channel shall be erected and concreted at locations as indicated by Mormugao Port Trust representative and as per approved signalling plan and shall be clear of all infringement.
- 42.2 The rail post and other fittings shall be painted as required.
- 43 **TELEPHONES:**
- Desk type Magneto telephone shall be fixed on the telephone stands/apparatus cases/battery boxes. The wooden stand shall be fabricated by the contractor and firmly fixed on to the wall if installed in station building platform/gate lodge. A suitable wooden box shall be manufactured for telephone battery with locking arrangements and fixed near the telephone. Telephones if installed in apparatus cases/battery boxes near the top points/ siding points/ home signals it shall be securely fixed on wooden shelves. Telephone battery shall be kept in the same apparatus case/ battery box. It shall be ensured that no other gadgets shall be kept in the apparatus case/ battery box and separate door lock arrangements shall be made to protect the telephone battery
- 44 **PAINTING:**
- 44.1 All signalling equipments shall be painted in accordance with the standard practice of the railway and signal engineering manual. While painting initially one coat of primer and afterwards two coats of enamel paint shall be applied. Paints and varnishes conforming to standard specification shall be used. The general practice of painting of some of the signal gears is given below:-
- 45 **SIGNAL POSTS AND FITTINGS:**
- 45.1 **Colour Light Signal:**
- a. Post. "White" (Aluminium paint should be used).
 - b. Fittings (Hood and Mechanism box) "Black",
The rear of the mechanism box and background may be painted white where necessary.
 - c. Inside of CLS unit: White enamel
- 45.2 **Electrical signalling apparatus:**
Point machines, key transmitters ... "Black"
- 45.3 **Junction boxes, battery boxes and apparatus cases:-**
- I) Junction boxes. Post type.
 - a) Inside "White"
 - b) Outside "Chocolate" (Red oxide paint should be used).

II) Junction boxes. Ground type and Apparatus cases:

- a) Inside "White"
- b) Outside "White" (Aluminium paint should be used).

45.4 CABLE MARKERS:

- a) Cable stakes ... 'Black'
- b) Cable markers ... 'Black'
- i. Body ... 'Black'
- ii. Figures ... 'White'
- c) Concrete cable marker - 'White'**

45.5 Indoor Painting:

45.5.1 Painting of complete relay rack/cable termination rack and ladder and its fixtures and other equipment installed in the relay room as per the instructions of Engineer and writing all cable termination numbering particulars in rack and also on board, relay numbering, nomenclature and other details both on relays and racks, rack numbering, particulars of condensers, fuses, resistances both at fixing boards as well as in the particulars board, axle counter equipment details, cable termination details and any other details as required in Relay Room for panel interlocking circuits by Engineer.

45.5.2 Painting equipment rack and all equipment numbering details, painting of hard wood planks provided on the equipment rack and power board racks, details of equipment fixed on power board.

45.5.3 Painting numbering on secondary cells, writing circuit details in the battery room as instructed by Engineer at site.

45.5.4 Painting generator panel particulars, instruction board to Operating staff, Generator numbers etc., in the Generator room.

45.5.5 Painting all termination particulars in the panel EKTs, Crank Handle box, axle counter resetting box, resetting plunger box in the SM's office/panel room.

45.6 Outdoor painting:

45.6.1 Supply of approved quality of paint and painting the following equipments in two coats duly scrapping the rust as directed by Engineer at site. The colours to be used are as given in Para 37.1 to 37.5 above.

- a) Colour light signal post complete with route indicators, ladders, calling on signals, shunt signals are to be painted both inside and outside including numbering of signals, cable termination details as per standard practice.
- b) Location boxes both inside and outside with location number, particulars of cable termination and other equipments kept inside the location.
- c) **Track Circuits:** Painting block joint numbers, feed/relay end details on rails, TLJBs, details of feed equipments with track circuit numbers and battery with track circuit number and date of installation.
- d) Point Machine layout complete including point number, circuit diagram inside the cover, junction box details point Contactor unit number in location box etc.,
- e) Key locked points with HPLs, connecting rods, point indicator, HKT tail cable termination particulars in the location box etc.

- f) Level crossing gate complete. Booms of LC gate shall be painted with luminous paint.
- g) The paint used for writing of signal numbers, A, P, C and G markers etc shall be photo luminous.

46 TESTING AND COMMISSIONING:

46.1 The electronic interlocking system shall be tested as per RDSO Spec. no.S-102/2004 and manufacturer should provide documents/literature/manuals for this purpose. Following important tests shall be carried out:

- a) Visual inspection.
- b) Insulation resistance test
- c) Power supply test.
- d) Card level functional test.
- e) System functional test.
- f) Route setting and signal interlocking test.
- g) System diagnostic test

46.2 Any other test required by Engineer. To maintain the records of different S&T equipments and related gears suitable registers shall be opened and maintained by contractor during the period maintenance is with him. The different stages and procedures for testing of indoor and outdoor equipments are given below as guidance. This testing shall be only applicable which is relevant in connection with electronic interlocking system and interface relay QN type.

46.3 Testing and commissioning consist of final testing of selection circuits, for proper functioning of track circuits and points, gears as per SEM, energising and testing of power cables, stabilizers, secondary cells for all circuits, energising and testing of colours light signals and final commissioning of the entire signalling arrangements for traffic use. The equipments shall be first tested by the Contractor's engineer and then jointly with MPT Consultant testing charges being borne by the contractor. The contractor shall provide test panel for testing at his own cost. The different stages and procedures for testing of indoor and outdoor equipments are given below as guidance. However detail testing shall be done in consultation with MPT consultant. As S&T part of the work may cater for all relay interlocking, SSI, therefore the testing procedure shall be followed suitable to these installation and other details given below:-

46.4 **STAGE-I**

Testing of the relay interlocking:

46.5 **STAGE-II**

Testing of the outdoor gears, viz., points, signals, track circuits, LC gates etc.

46.6 **STAGE-III**

Commissioning of cabin panel by connecting the outdoor gears to the cabin/panel.

46.7 **Testing of Relay Interlocking:**

Testing of relay interlocking consists of

- a) Energisation of relays by connecting the simulation panel.

- b) Clearing of signals on the simulation panel and carrying out the following tests (As per table of control):-
 - i. Negative tests
 - ii. Dead/ Approach locking tests.
 - iii. Route/Back locking tests.
 - iv. Testing of conflicting signals.
 - v. All other circuits viz., SM's key, CHLR, LXPR, KLCPR are provide correctly in the respective signalling circuits.

46.8 **Testing of Outdoor Gears:**

Testing of outdoor gears consist of:

- a) Signals
- b) Motor operated points
- c) Track circuits
- d) LC gates
- e) Slots.

46.9 **Commissioning of Panel**

Commissioning of panel consists of:-

- a) Testing all signals from panel and correspondence with field functions.
- b) Checking the correspondence between points and panel with panel indications.
- c) Checking the correspondence between the track circuits and its panel indications.
- d) Testing of EKT, panel indications.

46.10 **Testing of relay interlocking - energisation of relays by connecting simulation panel**

For major yards, it is preferable to energise relays, circuit wise and sheet wise, since it involves number of routes and parallel movements. For way station, it is preferable to energise the circuit, route wise:

Before taking up the above energisation, the following works shall be completed:

- a) Wire to wire bell test of all sheets before soldering and after soldering.
- b) Plugging of all relays as per contact configuration.
- c) Connection of Power supply arrangements with batteries.
- d) Connecting the simulation panel.
 - i) It shall be possible to control all TPRs, NWKR/RWKR, CHLRs, KLCRs, LXCPRs etc., from the simulation panel by energising all the relays.
 - ii) It is desirable to have the simulation panel adjacent to control panel so that the panel indication can be observed simultaneously while testing.

46.11 **Connecting Simulation Panel**

Simulation panel consists of two Boards:-

a) **BOARD No.1**

It depicts the yard (painted) with points, track circuits, LC gates and slots. Switches are fixed on the board to simulate the conditions of the points, track circuits, interlocked LC gates, slots etc.

Track circuit switches are fixed on the track. Point control switches are grouped as point switches and track circuit switches.

Functions requiring ON and OFF switch (with make and break facility i.e., two wires only) with facility to pick up a relay in one position and drop the same in other position. Example: Switch OFF - Track Down. - TPR dropped. Switch ON - Track pick up - TPR picked up. For controlling the following function the above type switched shall be used:-

- i. Track circuits
- ii. Siding point
- iii. Crank handle
- iv. Slot
- v. LC Gate

Points require ON and OFF switches with facility to pickup conflicting relays (i.e., NWKR and RWKR) in two positions. (These switches require three wires).

b) **BOARD No.2**

To simulate the signals the following bulbs are used as dummy loads for the ECRs to pick up and also to observe the aspect of the signals during testing.

ON aspect	:	110V 40 W
OFF aspect	:	110V 25 W
ROUTE aspect	:	110V 75 W

(Jn. Type route indicator)

c) Wiring simulation panel to the relay room side wiring at MDF:

46.12 **Testing of points:**

a) **Points:**

Points shall be tested first locally from the location box when point Contactor unit kept in location. Before commencing this test, ensure 110V DC, 24V DC are available in location box. If it is cross over point, it is preferable to test one by one and then test both at a time.

Disconnect all the links on cable termination rack. Wires from the switches are connected to the relay room side termination. Similarly the wires from simulation panel Board No.2 consisting of lamps are connected to the relay room side termination.

Multi core 0.6mm dia cable is used for wiring the simulation boards. To reduce the voltage drop, more conductors are used for supply taken to the test panel and also to the negative since common return is used.

46.13 Testing and Commissioning of Outdoor Equipments:

- a) Cable meggering and pairing up of conductors shall be done.
- b) All the power cables shall be made through and power supply shall be extended to all locations.
- c) After the power cables are energised, check up each limb of the power cable whether any earth fault exists using multimeter. This will indicate whether any cable conductor is faulty (i.e., earthed).

46.14 Testing of signals:

- a) Signals shall be initially tested from the Location Box to attend to minor troubles of wiring etc.,
- b) All the aspects shall be checked by giving 110 V AC feed from Location Box and then the test shall be repeated by giving feed from Relay room CT rack. This shall be repeated by giving feed from relay room CT rack. This test shall be done for each aspect, route and pilot lamp.
- c) Care shall be taken to ensure that no train is approaching during this test to avoid misleading information to drivers.
- d) Ensure that signal number plate is provided and unit back door is fastened and locked properly.
- e) Point Contractor unit with QBCA 1 Relays:

Connect B24V to W3 and N24V to W4. WCR picks up. Connect B24V to W2 and N24V to W1 to pick up RWCR to operate the point from normal to reverse. After the point operation is completed, loop RWCR, WCR by disconnecting the supply. Check up whether outgoing RWKR supply is available in location box. For reverse to normal operation, change the polarity on W1 and W2 and check. Care shall be taken to check whether correct wiring is done with regard to polarity.

III. Check up whether the cross protection wiring is done on the electrical detector.

IV) The following tests shall be carried out on Pt. Machines:-

- a) Obstruction test.
- b) Detection contact break test.
- c) Out of correspondence test (in case of cross over point).
- d) Track locking test (to be done when operated from panel). This test is to be done for both N to R and R to N operations.
- e) Whether point can be hand cranked with interlocked crank handle.
- f) Check the correspondence between point position at site when operated from Panel/VDU

46.15 Following tests shall be carried out on track circuits

- a) All the track circuits shall be energised and outgoing TPR voltage checked.
- b) Check whether cross protection wiring is done for TPR circuit.
- c) Shunt the track circuit at various places on the track and check whether the track relay drops every time it is shunted. (Especially near fouling marks).
- d) Check the correspondence between TR and TPR in relay room.

- e) Track circuit shall be adjusted properly and readings recorded.
TSR value shall be recorded.
- f) Check whether the track circuit is protecting the fouling point,.
- g) Ensure that at least one polarity rail is in series connection.
- h) Check up in put AC voltage to the track feed charges are sufficient and battery is getting charged.

46.16 **Testing of slot circuits:**

Slot circuits can be tested similar to that of signal HR circuits:

Negative tests, approach locking tests, back lock/route holding tests, cancellation of slots shall be tested similar to that of any signal in the yard as given in table of control.

46.17 **Commissioning of Panel**

- a) Check up all signals aspects by directly feeding from cable termination rack (110V AC).
- b) Check up operation of points from C.T. rack and check whether NWKR/RWKR incoming feed is available (by connecting 24V DC to W1, W2, W3 and W4 as explained earlier).
- c) Check up the incoming feed of TPRs in the C.T. rack. The above checking will confirm the pairing of cable conductors.
- d) Remove the wiring connection of simulation board on cable termination rack and make through the links of all TPRs, WKR and signal circuits.
- e) First test the points from panel individually and conduct all tests discussed earlier including track locking test, correspondence between point position and NWKR/RWKR in relay room.
- f) Check whether all TPRs have picked up and check up the panel indication individually by dropping each track circuit that it correspond correctly.
- g) Check whether all other required relays viz., CHLR, LXPR, KLCR have picked up.
- h) Test all the signals from panel.
- i) Check the correspondence between relay room and signal aspects which is most important.
- j) For checking the aspects staff (not below the rank of Engineer) shall be deputed to site with walkie-talkie or Magneto telephone and check the correspondence.
- k) Remove the connection for every aspect and check whether indication disappears on the panel and ECR drops in the relay room.
- l) Open all the registers and make entries of counter numbers before handing over to operating staff.

THE FOLLOWING REGISTERS SHALL BE HANDED OVER TO OPERATING STAFF:

- a) Relay room key register,
- b) Route cancellation register,
- c) Crank handle register,
- d) Diesel Oil consumption register (Generator working register)

THE FOLLOWING REGISTERS SHALL BE OPENED FOR SIGNAL MAINTENANCE STAFF:

- a) Track circuit history register,
 - b) Track circuit maintenance register,
 - c) Battery maintenance register,
 - d) Generator repair register.
 - e) Block joint maintenance register,
- 46.18 After functional test is completed and alterations done if needed, wire count shall be done for all the relays. While the circuit is read by contractor;s engineer, the site engineer repeat the number of wires found. If any difference appears the correctness of the same shall be established.
- 46.19 The relay disposition chart shall be prepared it shall be ensured that correct relay bases are fixed at their designated location. The relay names are correctly painted both on the front as well as backside of relay Rack.

47 GENERAL:

47.1 Signal and interlocking fittings:

All signal and interlocking fittings should be in accordance with I.R.S. specification No. S-10 with latest amendments unless otherwise specified.

47.2 All relay interlocking principles contained with latest amendments shall be applicable for all relay interlocking works. The arrangements of interlocking and design of equipment etc. shall be in conformity with the practices followed on SOUTH WESTERN RAILWAY and the System as a whole shall be so designed that the operation is reliable, safe and satisfactory under the local climatic conditions existing at the station.

47.3 Specifications, drawings, requisites and requirements referred to in the body of this specification form an essential part thereof. Whenever reference, to any standard of drawing appears in this document, it shall be taken as a reference to the latest version of that standard of drawing unless specifically stated.

47.4 Installation shall comply with requirements to the following manuals /books:-

- i) Signals Engineering Manual
- ii) Engineering Code.
- iii) General & subsidiary Rules with latest correction slip.

47.5 Information required to be submitted by the contractor vide App-'A'/App-'B' of the spec. IRS:S-36/87 are given below: -

47.6 Information to be supplied by the contractor in terms of Appendix-A of IRS:S-36/87:

A-1 Route setting type

AA-3 Signal interlocking plans of the yards and Selection Tables are attached.

A-4 The contractor should study the plan and site conditions. These should be taken into account while designing system for reliable operation.

A-5 Operating panel and indication panel shall be provided separately. All operating members shall be provided on the operating panel. The size and shape of the operating panel be such that two operator can conveniently operate it simultaneously.

It shall also comply with the following requirements:

47.7 The Buzzer indicating signal/point failure shall be common for all main and subsidiary signals and separate for points. Facility shall be available for muting the buzzer but failure indication will be available till the failure is rectified. Also indications to indicate button failures, etc, shall be provided.

47.8 The panels should show the highest workmanship and treatments like anti-rust coating, powder coating should be used to make the panel look decent. It should also withstand continuous use and heat (due to indication bulbs) and should be treated for long life. The name of the station shall be engraved on the panels conspicuously.

47.9 Panel tag block analysis and tool kit for panel containing two bulb extractors, eight magnets, and twenty reminder collars (Red) shall also be supplied along with the panel. Two sets of tool kits for panel shall be supplied.

47.10 The contractor shall provide perplex sheet cover on the operating as well as indication panel

47.11 Individual push button in conjunction with a common push button shall be provided for individual operation of points.

a) It shall be shown in the selection table.

b) It shall be as per signaling plan.

c) Constant voltage on signal lamps should be available.

Normally commercial supply feeds SSI In case of failure of both commercial supplies, the DG set should start automatically and the system should change over to DG set. In addition manual change over arrangement from any of the three sources should be possible to isolate the Automatic change over arrangement. The DG set should automatically stop as soon as any of the power sources as mentioned above resumes. Once DG set starts and then stops, then for restarting, sufficient time lag should be given for the safety of the DG set.

47.12 The voltage level and availability of different supplies should be displayed through meters separately for each source on the SM's power panel.

47.13 The following protections with necessary indication has to be incorporated in the circuitry for automatic change over.

Short circuit protection.

Over voltage protection.

Low voltage protection.

Single phase unbalancing current like any phase is out or earth fault etc.

Separate current meters for different phases also has to be provided.

47.14 All the indications should be as per the approved panel diagram. The type of indications for signals, points, routes with ref. to various paras of IRS:S-36/87 shall be as under:

47.15 White strip light indication to indicate the position of the point is required. The flashing indication for points not setting correctly is also required. The Buzzer indicating point failure shall be common for all points. Facility shall be available for muting the buzzer but failure indication will be available till the failure is rectified.

White light strip in horizontal position required.

White light strip in slanting position required.

47.16 Required. Flashing indication for the failure of signal aspect to be provided and the particular aspect not in correspondence with the control should flash till rectified. The Buzzer indicating signal failure shall be common for all signals. Facility shall be available for muting the buzzer but failure indication will be available till the failure is rectified.

47.17 Indication required both to indicate the slot/gate control/Crank handle for slot released as well as slot not released from the panel.

Meter is to be provided on the power panel.

LED, it should be provided preferably.

Type of symbols shall be as per para 4.1.1 of IRS:S-36/87.

Circuitry be as per Signal Interlocking Plan.

Sectional route release facility is required.

Details shall be available in the selection table.

Each end of the cross over shall be operated by separate point machine unless specifically shown on the Signal Interlocking plan.

The points are to be operated by 110VDC electric point machines.

DC track circuits will be provided as per SIP

Details of wires to be used for wiring shall be as per para 10.5 and 10.5.1 of IRS:S-36/87 but indoor cables/wires should conform to IRS:S-76/89 (latest) or IRS:S-35/93 (latest) or IRS:S-63/89 (latest).

A-41 (a) The Power Supply Scheme shall assume that in the locations/huts on the either side of the yard, the point contactor units/switching groups, track relays and lamp proving relays (as applicable) for the points, tracks and signals nearby shall be installed and hence the locations shall have to be provided with the necessary power supply to feed the points, the tracks, signals and to energise the track repeating relays and other repeating relays in the cabin. The main power supply from IPS required for these locations shall be distributed in a ring main fashion. Locations/huts shall have suitable power boards incorporating fuses, meters etc., to enable continuous monitoring of voltage and currents from each source of supply and

to each group of equipment to which the supply is made. All DC supplies in the locations/huts shall be provided with low maintenance cells of suitable capacity on float charge with the chargers capable of both trickle charging and boost charging. The power supply scheme shall not place any restriction on the number of points to be operated simultaneously.

There will be one 3 phase commercial supply, two nos. of single phase diesel generator supply (to be provided by the contractor).

There will be provision of auto-change over as well as manual changeover of the above supplies for the load via the Operator power panel to be provided by the contractor.

The outdoor cabling scheme shall utilize Un-screened cables, with conductor of size 1.5 sq.mm for all control circuits and signal lighting circuits. The maximum size of cable shall be 30core. Conductor size for power supply distribution shall be not less than 8 sq.mm. The cable run to be designed for laying from the Central Cabin to the various functions marked on the plan. The cables shall be PVC insulated to I.S.spec.1554 (latest) or IRS:S-76/89 (latest) or IRS:S-35/93 (latest) or IRS:S-63/89 (latest), as applicable.

- c) Terminal blocks (small) if used, shall conform to IRS:S-75/91 (latest) and RDSO drg.no.SA-23741 A(ADV) with latest Alteration instead of the specifications mentioned in para 11.6 of IRS:S-36/87.
- d) Indoor cables/wires shall conform to IRS:S-76/89 (latest) or IRS:S-35/93 (latest) or IRS:S-63/89 (latest), as applicable instead of IS-694 mentioned in para 10.5(b) of IRS:S-36/87.

110 volts AC supply on Un-screened cables would be used for feeding signals & route indicators.

110VDC operated Point machines are provided.

Point control circuits will ensure that once a point movement is initiated, it must be completed even if the controlling track circuit/circuits fail in the meantime.

Circuits which release routes for interlocking shall be controlled by slow operating relays so that any inadvertent operation of track circuit due to a surge or other factors will not result in release of the route or the interlocking.

i) Counters:

S.No.	Operation	Type of Counter
1	Emergency point operation	Common veeder Counter
2	Emergency route section release	Common veeder Counter
4	Emergency route release	Common veeder Counter
5	Overlap release	Common veeder Counter
6	Crank handle release operation	Separate veeder Counter for each group of Crank Handles

‘Suitable Electric counter’ mentioned in IRS: S-36/87 shall be a veeder counter.

AS MADE DETAILS:

After commissioning of the entire installation, as made tracings of documents/plans shall be made on tracing film of standard size using AutoCAD (R14 or latest) and handed over to Mormugao Port Trust along with 6 copies of the following plans, diagrams duly signed by competent authority. One CD shall also be handed over for these records.

- a) Signalling plan, selection table, Panel diagram.
- b) As made track bonding diagram
- c) As made cable plan
- d) As made cable route plan
- e) As made Location Box/apparatus case wiring diagram termination and cable particulars.
- f) As made cable termination rack particulars.
- g) Cable meggering readings
- h) Relays and other equipments details (Field equipments).
- i) Wiring diagrams.
- j) Relay contact particulars
- k) Power diagram duly indicating the power supply details and position of the equipment.
- l) Fuse and tag block analysis.
- m) Any other diagram required by MPT/consultant in connection with the work.

CHAPTER-IX
TENDER SCHEDULE

Name of Work: Providing Signalling and Telecommunication System for Railway Network at Mormugao Port, Goa.

Detailed BOQ

Enclosed as Annexure-I

Note:

- 1) Tenderers are requested to inspect the site of installation before quoting the rates.
- 2) For Drawing & RDSO specifications refer to the latest issue.
- 3) The cost of supply of minor materials and accessories other than specification & condition but necessary for Installation, should be included while quoting the rates.
- 4) Tenderer shall not quote rate for individual items.
- 5) Tenderer should only quote percentage above or below the total estimated cost in Price Bid Document.
- 6) If any deviation noticed in the certificate endorsed below, Mormugao Port Trust decision shall be final.
- 7) Tenderer should complete & sign the following certificate⁹. Rates quoted elsewhere other than the specified spare on Schedule of Material & Works shall not be considered for evaluation of the offer.

CODE OF PRACTICE FOR EARTHING AND BONDING SYSTEM FOR SIGNALLING EQUIPMENTS

1. Scope

This document covers earthing & bonding system to be adopted for signalling equipments with solid state components which are more susceptible to damage due to surges, transients and over voltages being encountered in the system due to lightning, sub-station switching etc. These signalling equipments include Electronic Interlocking, Integrated Power supply equipment, Digital Axle counter, Data logger etc.

2. References

IS 3043	Code of practice for earthing
ANSI/UL 467	<i>Grounding & bonding equipment</i>
IEEE 80	<i>IEEE guide for Safety in AC sub-station grounding</i>
IEEE 837	<i>Standard for qualifying permanent connections used in substation grounding</i>
IEC 62305	<i>Protection against lightning</i>

3. Importance of Earthing

The installation and maintenance of an effective low resistance earthing system is essential due to the following -

- Efficiently dissipate heavy fault currents and electrical surges, both in magnitude and duration, to protect equipment being damaged so as to minimize down time, service interruption and replacement cost.
- Provide a stable reference for electrical and RF circuits at the installation to minimize noise during normal operation.
- Protection of personnel who work within the area from dangerous electric shock caused due to “step potential” or “touch potential”.

4. Characteristics of good Earthing system

- Excellent electrical conductivity
 - Low resistance and electrical impedance.
 - Conductors of sufficient dimensions capable of withstanding high fault currents with no evidence of fusing or mechanical deterioration.
 - Lower earth resistance ensures that energy is dissipated into the ground in the safest possible manner.
 - Lower the earth circuit impedance, the more likely that high frequency lightning impulses will flow through the ground electrode path, in preference to any other path.
- High corrosion resistance

The choice of the material for grounding conductors, electrodes and connections is vital as most of the grounding system will be buried in the earth mass for many years. Copper is by far the most common material used. In addition to its inherent high

conductivity, copper is usually cathodic with respect to other metals in association with grounding sites, which means that it is less likely to corrode in most environments.

- Mechanically robust and reliable.

5. **Location for Earth**

- Low lying areas close to the building or equipment are good for locating Earth Electrodes.
- The location can be close to any existing water bodies or water points but not naturally well-drained.
- Dry sand, lime stone, granite and any stony ground should be avoided.
- Earthing electrode should not be installed on high bank or made-up soil.

6. **Acceptable Earth Resistance value**

The acceptable Earth Resistance at earth busbar shall not be more than 1 ohm.

7. **Components of Earthing & Bonding system**

The components of Earthing & Bonding system are- Earth electrode, Earth enhancement material, Earth pit, Equi-potential earth busbar, connecting cable & tape/strip and all other associated accessories.

8. **Design of Earthing & Bonding system**

8.1. **Earth Electrode**

- The earth electrode shall be made of high tensile low carbon steel circular rods, molecularly bonded with copper on outer surface to meet the requirements of Underwriters Laboratories (UL) 467-2007 or latest. Such copper bonded steel cored rod is preferred due to its overall combination of strength, corrosion resistance, low resistance path to earth and cost effectiveness.
- The earth electrode shall be UL listed and of minimum 17.0mm diameter and minimum 3.0mtrs. long.
- The minimum copper bonding thickness shall be of 250 microns.
- Marking: UL marking, Manufacturer's name or trade name, length, diameter, catalogue number must be punched on every earth electrode.
- Earth electrode can be visually inspected, checked for dimensions and thickness of copper coating using micron gauge. The supplier shall arrange for such inspection at the time of supply, if so desired.

8.2. **Earth Enhancement material**

Earth enhancement material is a superior conductive material that improves earthing effectiveness, especially in areas of poor conductivity (rocky ground, areas of moisture variation, sandy soils etc.). It improves conductivity of the earth electrode and ground contact area. It shall have following characteristics-

- Shall mainly consist of Graphite and Portland cement. Bentonite content shall be negligible.
- Shall have high conductivity, improves earth's absorbing power and humidity retention capability.

- Shall be non-corrosive in nature having low water solubility but highly hygroscopic.
- Shall have resistivity of less than 0.2 ohms-meter. Resistivity shall be tested by making a 20cm. cube of the material and checking resistance of the cube at the ends. The supplier shall arrange for such testing at the time of supply, if so desired. Necessary certificate from National/ International lab for the resistivity shall also be submitted.
- Shall be suitable for installation in dry form or in a slurry form.
- Shall not depend on the continuous presence of water to maintain its conductivity.
- Shall be permanent & maintenance free and in its “set form”, maintains constant earth resistance with time.
- Shall be thermally stable between -100 C to +600 C ambient temperatures.
- Shall not dissolve, decompose or leach out with time.
- Shall not require periodic charging treatment nor replacement and maintenance.
- Shall be suitable for any kind of electrode and all kinds of soils of different resistivity.
- Shall not pollute the soil or local water table and meets environmental friendly requirements for landfill.
- Shall not be explosive.
- Shall not cause burns, irritation to eye, skin etc.
- Marking: The Earth enhancement material shall be supplied in sealed, moisture proof bags. These bags shall be marked with Manufacturer’s name or trade name, quantity etc.

8.3. **Backfill material**

The excavated soil is suitable as a backfill but should be sieved to remove any large stones and placed around the electrode taking care to ensure that it is well compacted. Material like sand, salt, coke breeze, cinders and ash shall not be used because of its acidic and corrosive nature.

8.4. **Earth Pit**

8.4.1. **Construction of unit earth pit:** Refer typical installation drawing no. SDO/ RDSO/ E&B/ 001.

- A hole of 100mm to 125mm dia shall be augured /dug to a depth of about 2.8 meters.
- The earth electrode shall be placed into this hole.
- It will be penetrated into the soil by gently driving on the top of the rod. Here natural soil is assumed to be available at the bottom of the electrode so that min. 150 mm of the electrode shall be inserted in the natural soil.
- Earth enhancement material (minimum approx. 30-35 kg) shall be filled into the augured/dug hole in slurry form and allowed to set. After the material gets set, the diameter of the composite structure (earth electrode + earth enhancement material) shall be of minimum 100mm dia covering entire length of the hole.

- Remaining portion of the hole shall be covered by backfill soil, which is taken out during auguring /digging.
- A copper strip of 150mmX25mmX6mm shall be exothermically welded to main earth electrode for taking the connection to the main equi-potential earth busbar in the equipment room and to other earth pits, if any.
- Exothermic weld material shall be UL listed and tested as per provisions of IEEE 837 by NABL/ ILAC member labs.
- The main earth pit shall be located as near to the main equi-potential earth busbar in the equipment room as possible.

8.4.2. **Construction of loop Earth by providing multiple earth pits**

- At certain locations, it may not be possible to achieve earth resistance of $\leq 1\text{ohm}$ with one earth electrode /pit due to higher soil resistivity. In such cases, provision of loop earth consisting of more than one earth pit shall be done. The number of pits required shall be decided based on the resistance achieved for the earth pits already installed. The procedure mentioned above for one earth pit shall be repeated for other earth pits.
- The distance between two successive earth electrodes shall be min. 3mtrs. and max. upto twice the length of the earth electrode i.e. 6 mtrs. approx.
- These earth pits shall then be inter linked using 25X2 mm. copper tape to form a loop using exothermic welding technique.
- The interconnecting tape shall be buried at depth not less than 500mm below the ground level. This interconnecting tape shall also be covered with earth enhancing compound.

8.4.3. **Measurement of Earth resistance**

The earth resistance shall be measured at the Main Equi-potential Earth Busbar (MEEB) with all the earth pits interconnected using Fall of Potential method as per para 37 of IS: 3043.

8.4.4. **Inspection Chamber**

- A 300x300x300 mm (inside dimension) concrete box with smooth cement plaster finish shall be provided on the top of the pit. A concrete lid, painted black, approx. 50 mm. thick with pulling hooks, shall be provided to cover the earth pit.
- Care shall be taken regarding level of the floor surrounding the earth so that the connector is not too deep in the masonry or projecting out of it.
- On backside of the cover, date of the testing and average resistance value shall be written with yellow paint on black background.

8.5. **Equipotential Earth Busbar and its connection to equipments & Surge protection devices in the Equipment room:** Refer typical bonding connections drawing no.SDO/RDSO/E&B/002.

8.5.1. Equi-potential Earth Busbars

There shall be one equi-potential earth busbar for each of the equipment room i.e. IPS/Battery charger room and EI/Relay room. The equi-potential earth busbars located in individual rooms shall be termed as Sub equi-potential busbars (SEEB). The equi-potential earth busbar located in the IPS /Battery charger room and directly

connected to Class 'B' SPDs and the main earth pit shall be termed as Main equipotential earth busbar (MEEB).

The EEBs shall have pre-drilled holes of suitable size for termination of bonding conductors. The EEBs shall be insulated from the building walls. Each EEB shall be installed on the wall with low voltage insulator spacers of height 60mm. The insulators used shall have suitable insulating and fire resistant properties for this application. The EEBs shall be installed at the height of 0.5m from the room floor surface for ease of installation & maintenance. All terminations on the EEBs shall be by using copper lugs with spring washers.

8.5.2. **Bonding Connections**

To minimize the effect of circulating earth loops and to provide equi-potential bonding, "star type" bonding connection is required. As such, each of the SEEBs installed in the rooms shall be directly connected to MEEB using bonding conductors. Also, equipment/racks in the room shall be directly connected to its SEEB. The bonding conductors shall be bonded to their respective lugs by exothermic welding.

8.5.3. All connections i.e. routing of bonding conductors from equipments to SEEB & from SEEBs to MEEB shall be as short and as direct as possible with min. bends and separated from other wiring. However, connection from SPD to MEEB shall be as short as possible and preferably without any bend.

8.5.4. Materials and dimensions of bonding components for connection of individual equipments with equipotential bus bar and earth electrode shall be as given below.

Component/Bonding	Component/Bonding Material	Size
Main Equipotential Earth Bus Bar (MEEB)	Copper	300X25X6 mm(min)
Sub Equipotential Earth Bus Bar (SEEB)	Copper	150X25X6 mm(min)
Individual equipments to SEEB using copper lugs with stainless steel nut and bolts	Multi-strand single core PVC insulated copper cable as per IS:694	10 sq.mm
SEEB to MEEB using copper lugs with stainless steel nut and bolts.	Multi-strand single core PVC insulated copper cable as per IS:694	16 sq.mm
Surge Protection Devices (SPD) to MEEB using copper lugs with stainless steel nut and bolts.	Multi-strand single core PVC insulated copper cable as per IS:694	16sq.mm
MEEB to main earth electrode	Multi-strand single core PVC insulated copper cable as per IS:694 (Duplicated)	35sq.mm
Main earth pit to other earth pit in case of loop earth	Copper tape	25X2 mm

9. **Drawing of Earthing & Bonding System**

The complete layout with dimensions of the earthing & bonding system shall be submitted by the supplier after commissioning.

10. **Warranty**

The supplier shall be responsible for complete supply, installation & commissioning of the earthing & bonding system. The warranty of such system shall be 60 months from date of commissioning. During this period,

any failure of earthing system due to improper materials & bad workmanship shall be attended free of cost by the supplier.

11. **Maintenance of earthing & bonding system**

The maintenance schedule should cover verification of earthing system conductors and components, verification of electrical continuity, measurement of earth resistance, re-fastening of components and conductors etc.

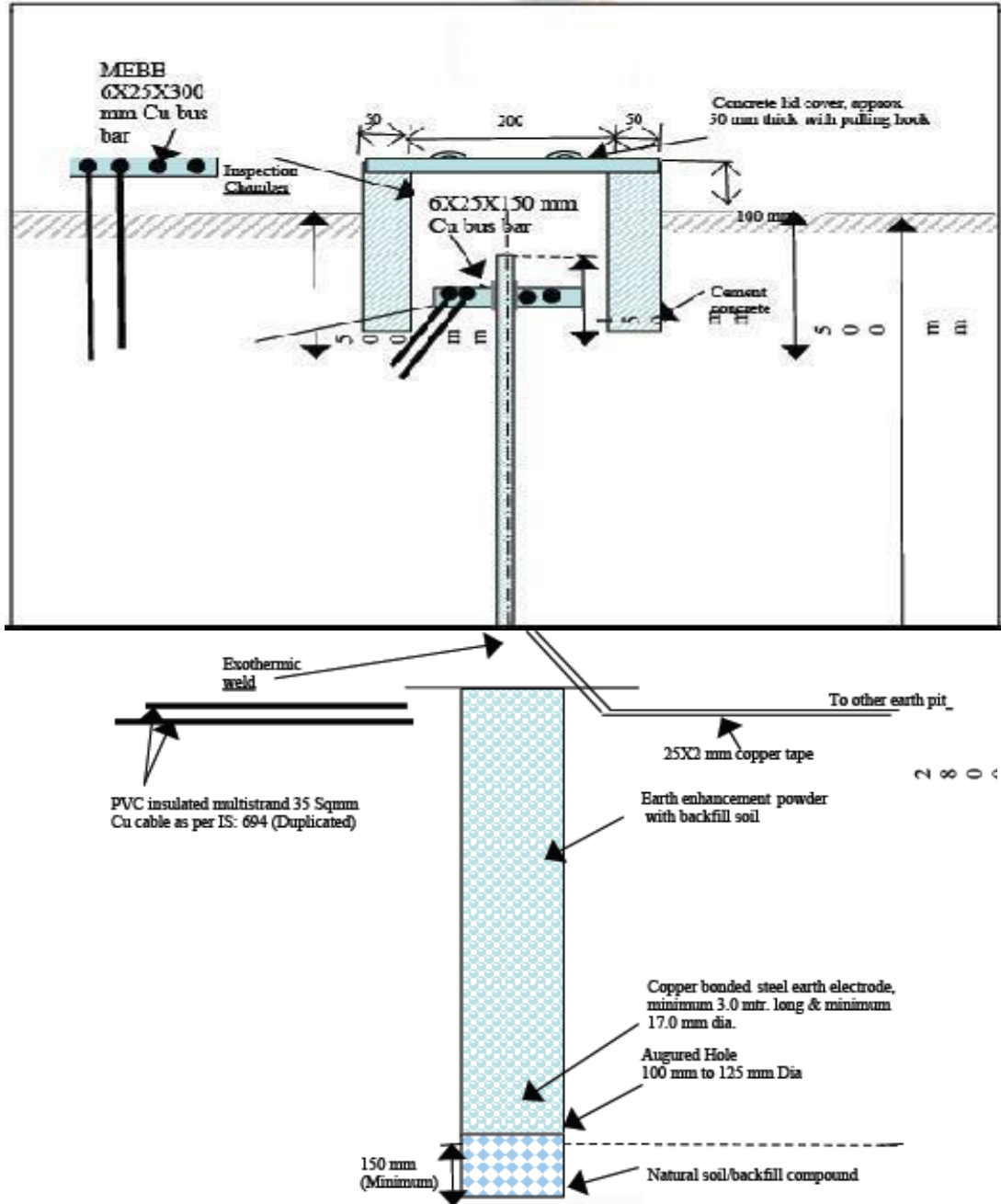

RDSO				
Typical installation of earth for S&T Installations				
JE/SE/ Sig	ADE/Sig	For DG/Sig	Drg. No. SDO / RDSO/E&B/001 Date:19.09.08	Sheet No. 1 of 1

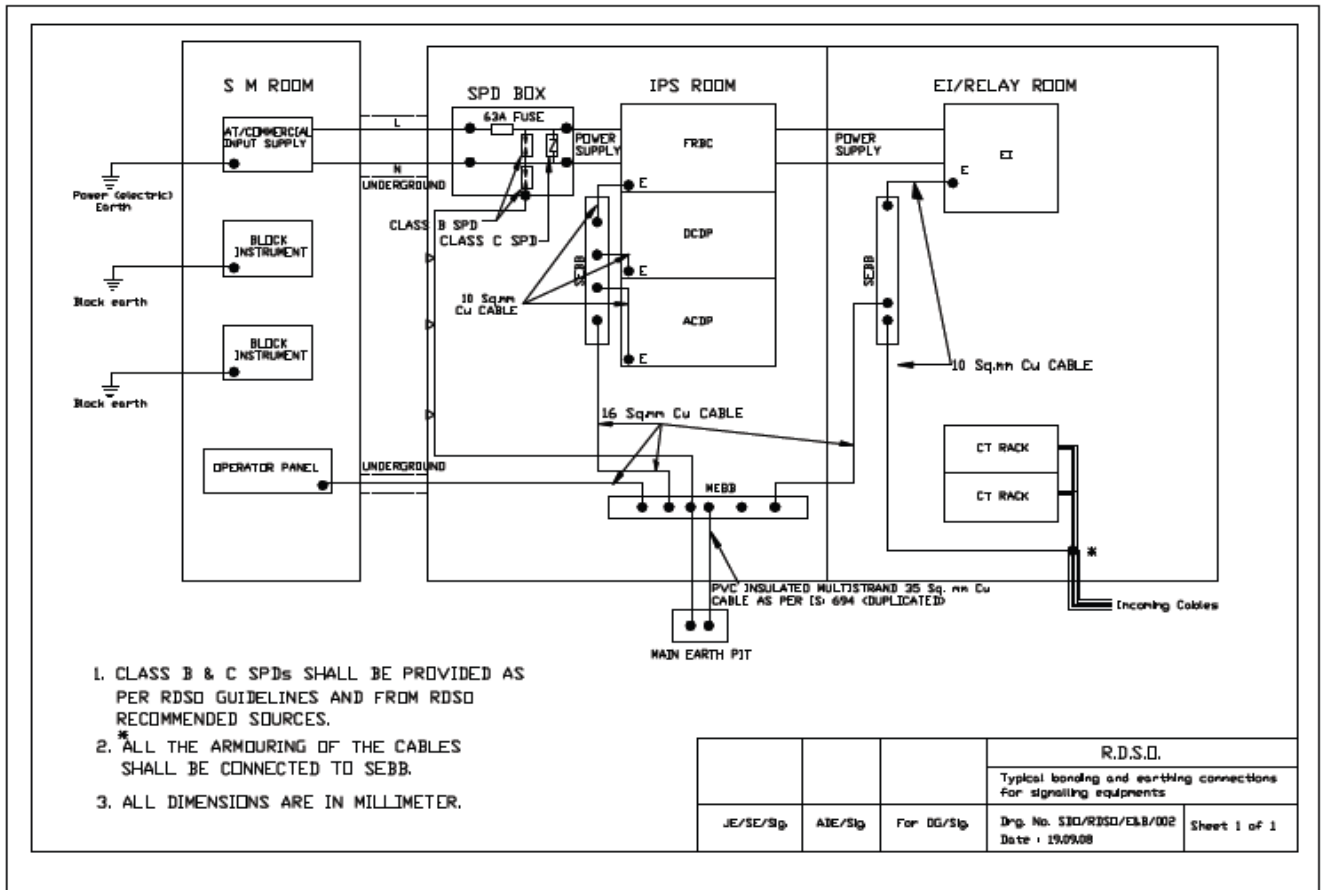

DRAWINGS

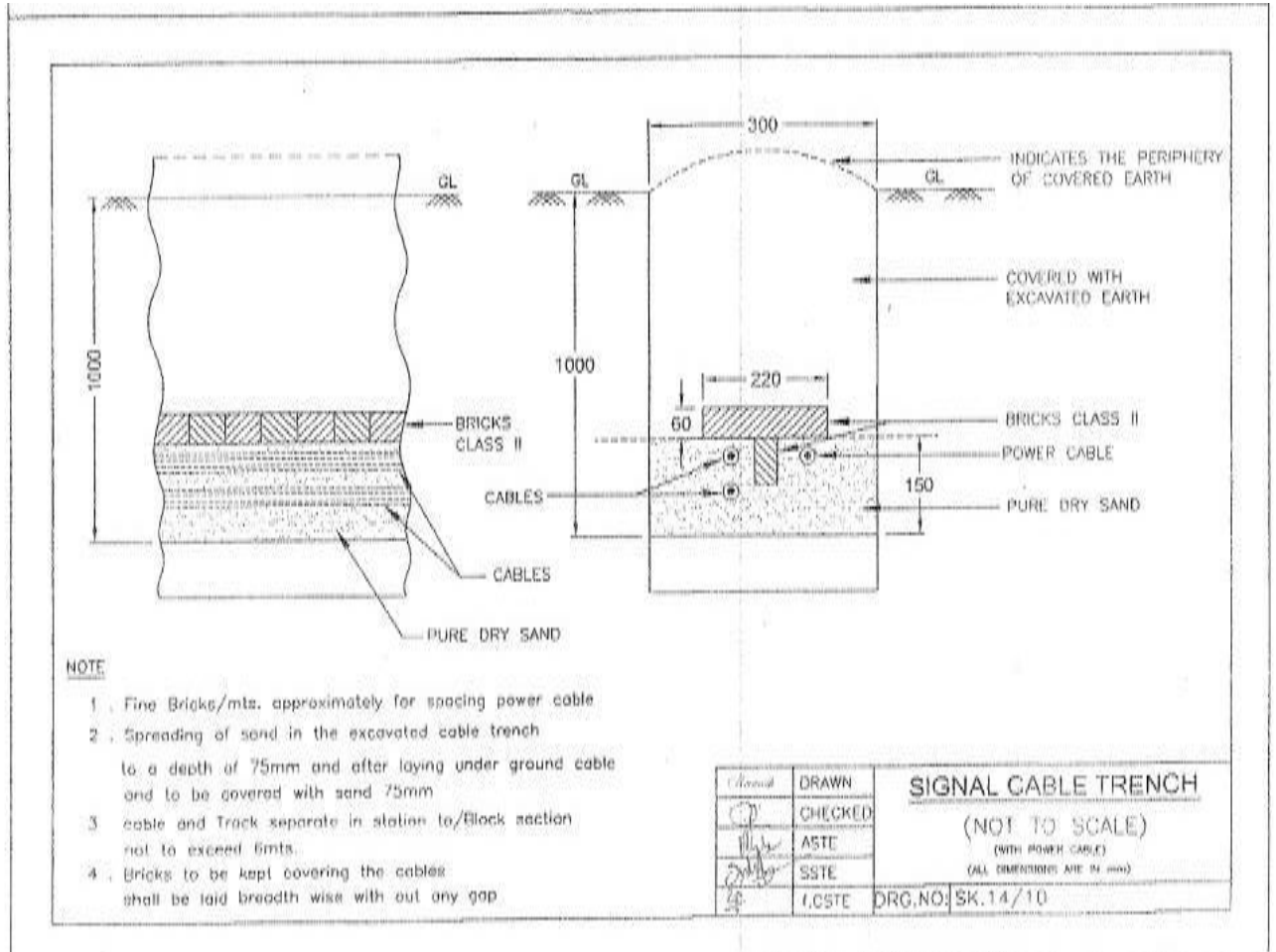

Note: Copies of the IRS drawings and specifications, according to which the works have to be executed, have to be obtained by the Tenderer directly from the Director General, RDSO, S&T Wing, Alambagh, Lucknow-5.

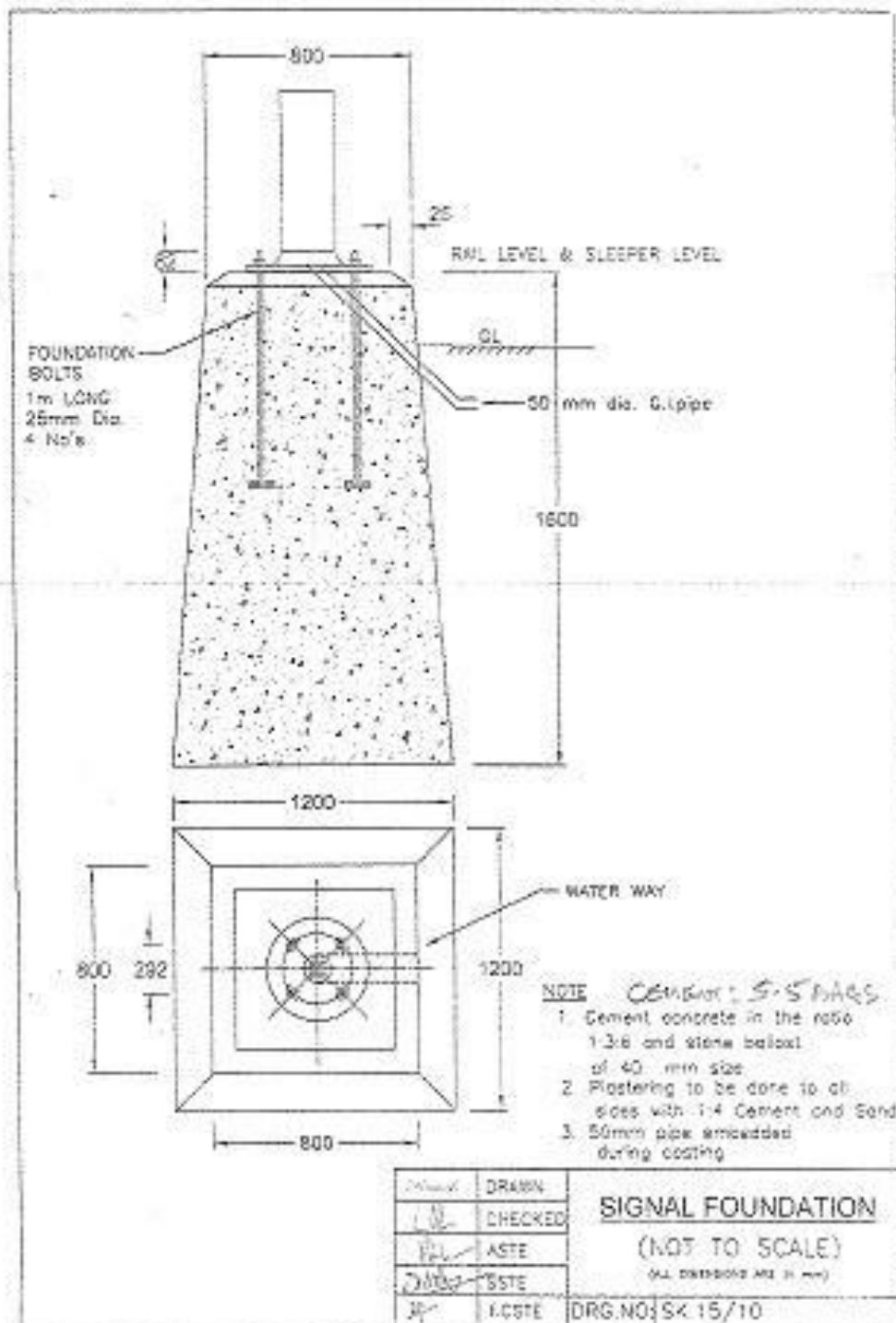

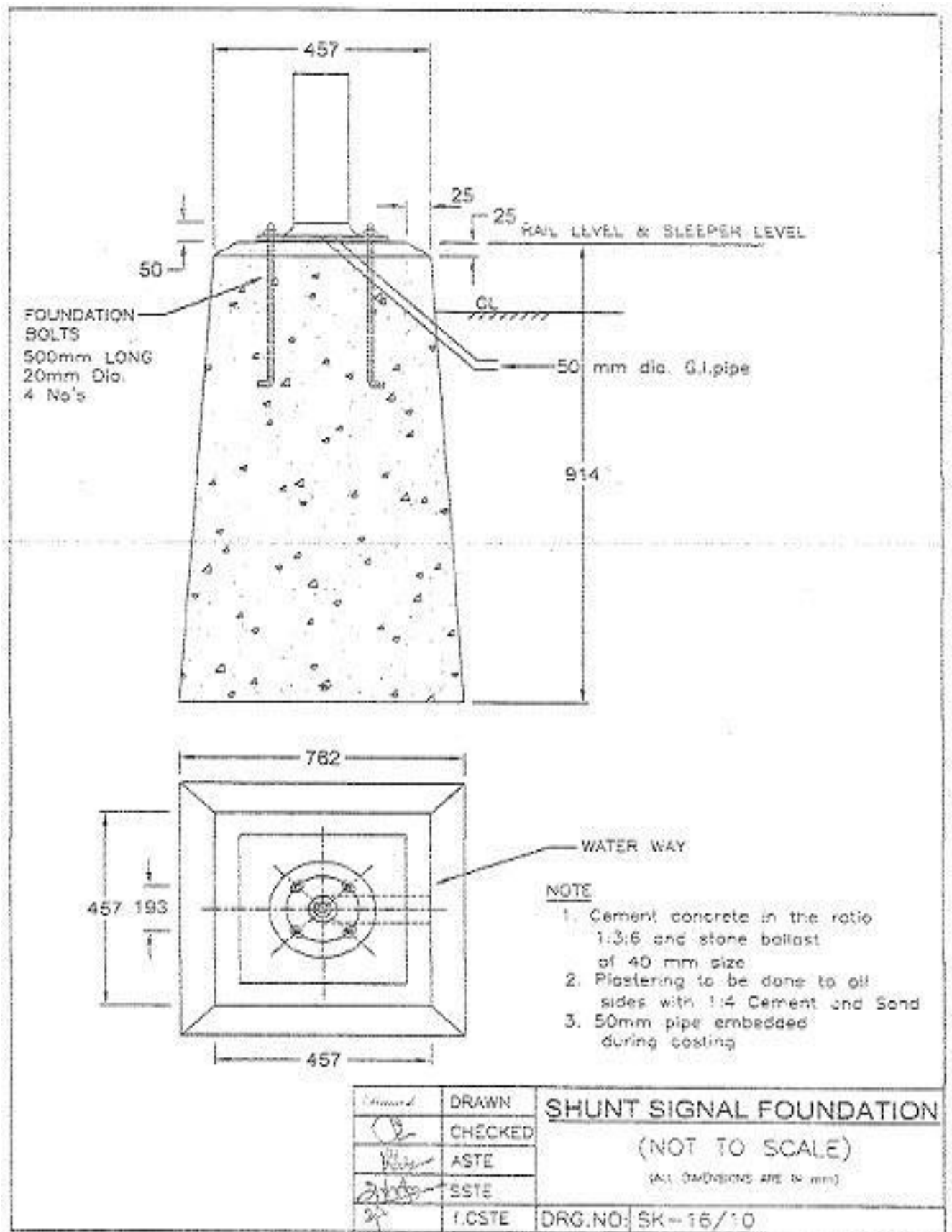

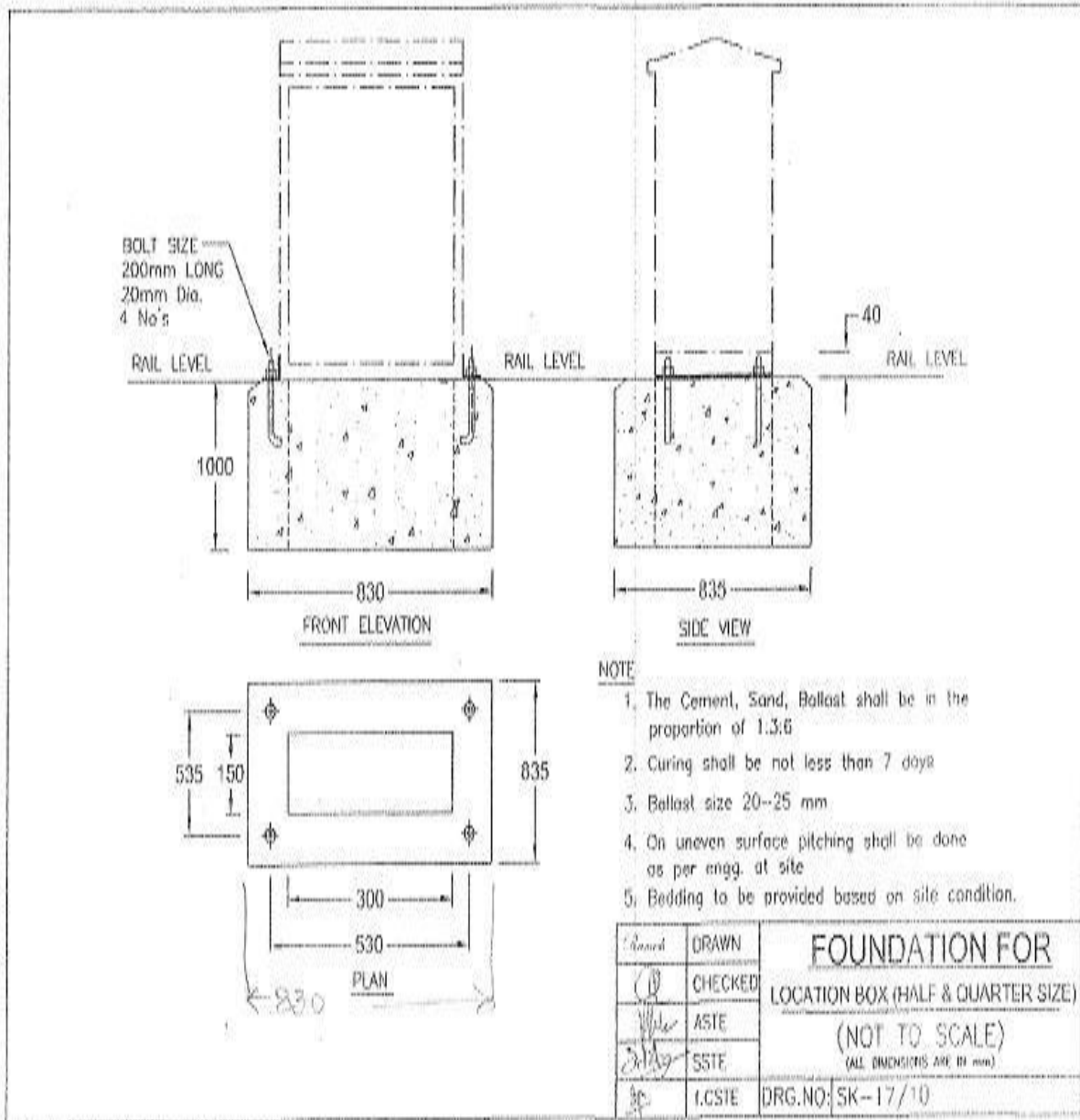

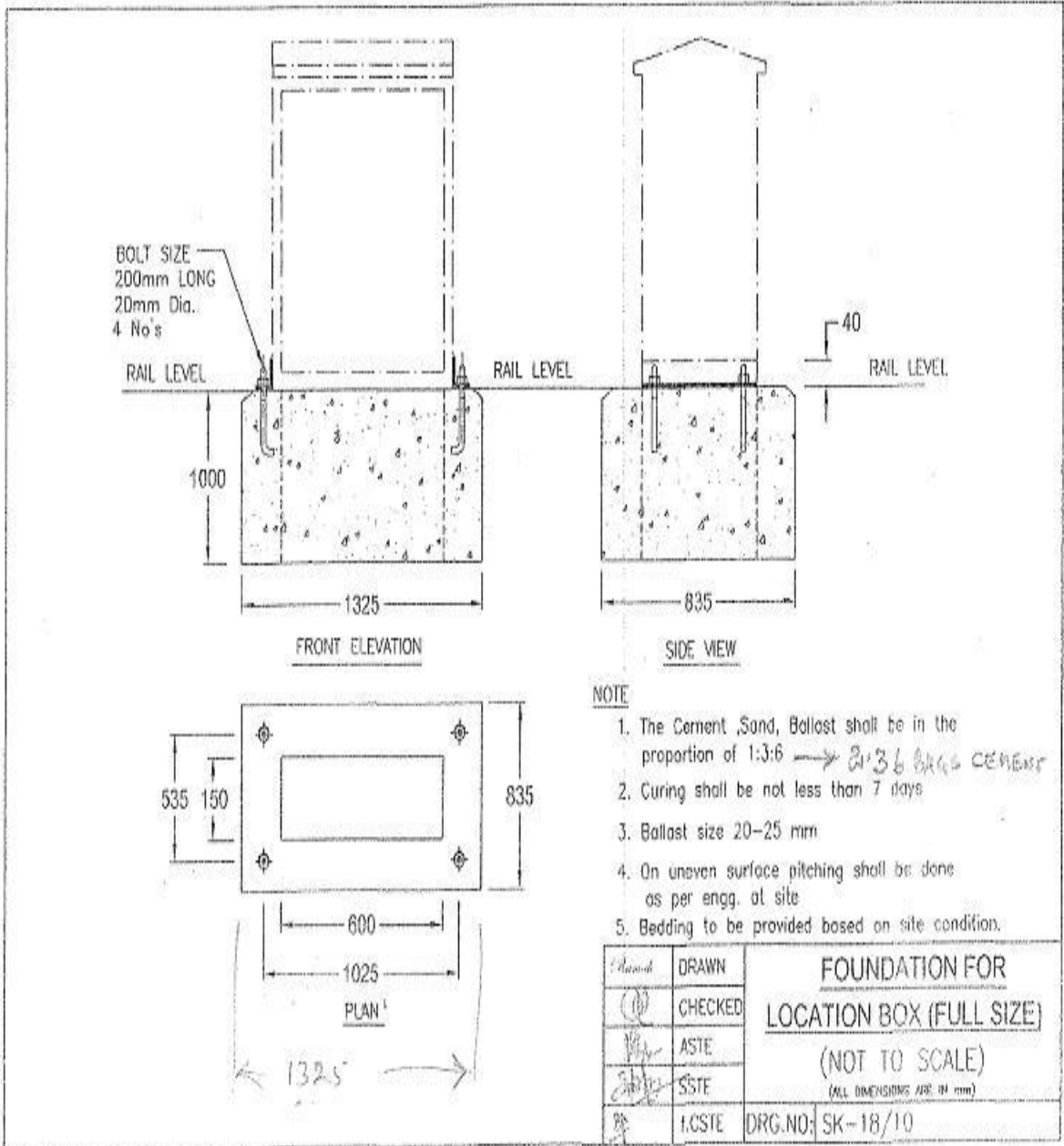

LIST OF SIGNALING MATERIALS WITH THEIR SPECIFICATION

The Signalling & Telecom Materials to be supplied by the contractor will be to the following specifications/drawings with the latest amendments:

SIGNALLING ITEMS:

S.No	Description of Item	Specifications
	Interlocking Related:	
1	Electronic Interlocking	RDSO/SPN/192/2005
2	Data logger	IRS: S-99/2006
	Power Supply Related:	
3	Integrated power supply	RDSO/SPN/165/2004
4	Automatic change over unit of 10KVA 63A	RDSO Spec. No. TI/SPC/PSI/CLS/0023 with amendment no.3
5	Diesel Generator	BS:649/5514
	Equipments Monitoring Related:	
6	Failure analysis system	I5 processor 1 TB HDD ,4GB Ram , loaded with Window 8 as OS,DVD Writer of branded make like HP
	Relays:	
7	Plug-in type, style ' QN1, neutral line relays	BRS-931A, IRS-S-34, IRS-S-23
8	Plug-in type, style ' QT2, neutral Track relays	BRS-939A, IRS-S-34, IRS-S-23
10	AC LED lamp proving relay	110V AC LED Signal/09/2002,BRS941A
	Indoor Equipment Related:	
11	Non-Deteriorating type low voltage electric fuse with fuse holder	RDSO/SPN/IRS:S-78/92
12	Screw less mounted 2.6Sq.mm, 4-wire front entry, two input Two output, Disconnected Cage Clamp Terminal block for test and measurement	RDSO/SPN/189/2004
13	Electronic Flasher Relay	RDSO/SPN/173/2002
	Indoor Jumper Related:	
14	PVC insulated Indoor Multi Core Cable	IRS/S:76/89
15	PVC Insulated Armoured , Power Cable	IRS/S:63/2007(Amd.3) & IS:1554 (Part-1)
	Track Circuits Related:	
16	Track Feed battery charger	RDSO spec no. S-89/93
17	Track Feed variable resistance	RDSO Drg no.SA-20166/Adv(latest)

S.No	Description of Item	Specifications
18	Lead acid stationary secondary cells	RDSO Spec no. IRS: S-88/93
19	Bonding wire	IS-279/81
20	Single groove Channel pins	S-17/75
	Earthing & Lightning Protecting Related:	
21	Earth Leakage Detector	RDSO/SPN/256/2002
	Points Related:	
22	Electrical Point Machine	IRS-S-24/2002 & Motor IRS: S37/82, assembly Drg No. RDSO:S10800 &S10910
23	Point Ground Connections for 143 mm throw IRS type point machine complete(Five Rods) & Switch extension bracket	Drg No. I0SA8805, II) RDSO/S/3273, III) RDSO/S/3271, IV) RDSO/S/3267, V) RDSO/S/3269 & RDSO/S/3264 , drive lug S:8806
24	E-Type lock with Keys	RDSO Drg NO. SA 33/6
25	Gauge tie plate	IRS-S-23 & 40
	Apparatus Cases Related:	
26	PBT ARA Terminals	IRS Spec. No. IRS-S-75/91
	Signals Related:	
27	Independent Shunt signal unit	RDSO Drg no. S-23840 Adv & Spec-S-23/88
28	LED type shunt signal lamp	RDSO/SPN/153/2002
	Signalling Cables Related:	
29	Underground Railway Signalling Cables Of Different Cores	IRS:S-63/2007(AMD-3) or Latest

TELECOMMUNICATION ITEMS:

S.No	Description of Item	Specifications
	Telecom Cables Related:	
1	6 Quad Jelly Filled Telecommunication Cable	TC/30/2005.Amendment 2 or Latest
2	Jointing Quard jelly filled cable	IRS: TC-77/2010 or (Rev-02)
	Jelly Filled Cables Related:	
3	PIJF- Polythene insulated filled telephone cable	IRS: TC-41/97 Amendment No.1 or Latest
	Switch Board Cable:	
4	Switch Board Cable 20 Pair	IRS: TC-24/97
	Other Equipments:	
5	VF Transformer	IRS: TC-22/76
6	CT Box	IRS: TC-GR/WIR-06/03(2002) spec IRS:TC-36/97
7	Double Walled Corrugated pipes	IS-14930

Details of Maintainer's Tool Kit

S.No.	DESCRIPTION OF Item	UNIT	QTY.	Rate	Inspection By
1	Standard Tool Bag Canvas	Nos	1		
2	Soldering Iron 60W/230V	Nos	1		
3	Multi Meter Fluke/Philips 20 meg Ohms, 10A DC, 5 Khz, 2MV to 750V Ac, 200VDC,	Nos	1		
4	Cutting Plier 6" Taparia Make	Nos	1		
5	Side Cutter 6" Taparia make	Nos	1		
6	Wire Strpper Taparia Make	Nos	1		
7	Fibre Tape 3 meteres	Nos	1		
8	Steel Scale 6" (SS)	Nos	1		
9	Hammer 3 Lb	Nos	1		
10	Chisel 6" (for cutting Bond Wire)	Nos	1		
11	Screw driver Heavey duty 12"	Nos	1		
12	Fiber type	Nos	1		
13	Point Machine Test Piece	Nos	1		
14	Universal Key	Nos	1		
15	Box Spanner for 6 way 13mm,	Nos	1		
16	Nylon Brush	Nos	1		
17	Sealing Plier	Nos	1		
18	Crimping Tool 1.5 to 16 sqmm	Nos	1		
19	Feeler Gauge	Nos	1		
20	TSR Meter Track circuit condition	Nos	1		
21	Track Shorting Clips	Nos	1		
22	Electrical Tester	Nos	1		
23	Flat file 12" length	Nos	1		

SSI Tool Kit

S.No.	Crimping Tool 48/96 Pin	No	1		
1	Crimping Tool 48/96 Pin	No	1		
2	Insertion Tool 48 Pin	Nos	1		
3	Removal Tool 48 pin	Nos	1		
4	Locator Tool 48/96 Pin	Nos	1		
5	Insertion tool 96 Pin	Nos	1		
6	Removal Tool 96 Pin	Nos	1		
7	Digital Multimeter 4 and ½ digit	Nos	1		

xvii) VENDOR REGISTRATION FORM

1. Name of the Organization : _____
2. Address (In Detail) : _____

3. Telephone Number : _____
4. E-Mail Id : _____
5. Permanent Account Number (PAN) : _____
6. Bank Name : _____
7. Bank Branch Address (In Detail) : _____

8. Bank Branch Code : _____
9. Bank Account Number : _____
10. Bank Account Type : _____
11. Magnetic Ink Character Recognizer (MICR) : _____
12. Tax Identification Number (TIN) : _____
13. Service Tax Registration Number : _____

14. Service Tax Registration Code : _____
15. CST Registration Number : _____
16. Employee Provident Fund (EPF)
Registration Number : _____
17. Employee State Insurance Scheme
(ESIS) Registration Number : _____
18. IFSC Code : _____